



| | |
|-----------------|-------|
| Catalog Number: | |
| Project: | |
| Comments: | |
| Prepared By: | Date: |

Description

The sleek fixture design of the LDS-SFL is a blend of modern sophistication and unmatched energy efficiency. The LDS-SFL small area light includes the benefits of superior thermal efficiency, an industry-leading ten-year all-parts warranty, and custom optics ensuring best-in-class photometric results. Optimize photometric designs with greater pole spacing, uniformity, and lower energy usage. The LDS-SFL includes lumen packages up to 30,000 lumens allowing one-for-one replacements of existing HID fixtures up to 1000 Watt and is a perfect spec-grade solution for parking lots, pathways, tennis courts, and many other outdoor applications. Proudly Made in the USA.

Dimensions & Weights

| Model | Width | Length | Height | Weight |
|---------|--------|----------------------------|----------------------------|--------|
| LDS-SFL | 13.25" | 19.38" (SF) 21.71" (SB) | 20.43" (SF) 20.68" (SB) | 15 lbs |

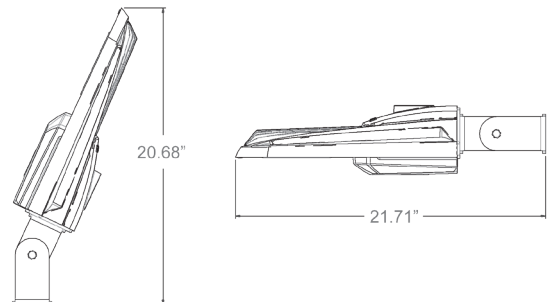
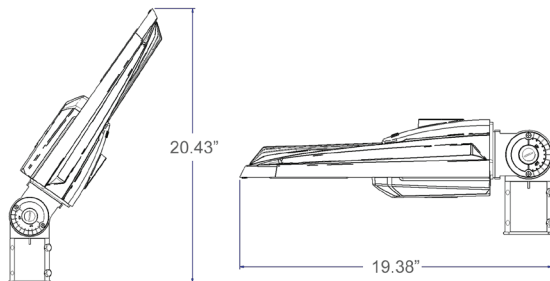

Technical Specifications

Input Voltage: 120-277V or 347-480V.

Housing: Die-cast aluminum housing with 60% gloss polyester powder coat finishes for maximum durability. The base aluminum material is prepared using an environmentally-friendly non-chrome 2-step surface cleaning and passivation process. The process results in a more durable conversion layer than traditional chromate conversion coatings and allows maximum adhesion of the powder coating to the aluminum substrate. Housing features an integrated heat sink and driver compartment built into the fixture design.

Mounting: Two-piece swivel bracket (standard). Additional mounting options include: slip fitter.

Split Circuit: Optional

Effective Projected Area (EPA): 1.75 ft²

Color Temperature: 2200K, 2700K, 3000K, 4000K (standard), 5000K.

LED Lifetime: All LEDs are rated for a minimum of 100,000 hours of continuous operation at ambient outdoor temperatures from -40°F/-40°C to 115°F/46°C.

Color Rendering Index (CRI): Minimum of 80 or higher. CRI 90+ available upon request. CRI 90+ not available in 2200K.

Dimming: 0-10V standard dimming capability.

Custom Optics: Lumecon meticulously engineered premium acrylic optical lenses to maximize the distribution and uniformity of light while minimizing cost. Our arrays distribute light at least 21% further and with 29% more uniformity than leading competitors. Lumecon custom lenses create a uniform, well-lit environment that mitigates illuminance "hot spots" and use less wattage than typical LED area lights.

Vandal Resistant: Our lens is also resistant to vandalism with a low compact design making the lens material dense and impact resistant. We build to withstand high abuse lighting environments.

Surge Protection: Thermally protected 40kV varistor type surge suppressor is included and meets ANSI C136.2-2015: Extreme Level. Also meets IEC61643-11 Class II / EN61643-11 Type 2, and US Dept of Energy MSSLC Model Spec for surge protection. The device is wired in series with the luminaire input power in order to interrupt power to the luminaire when consumed, protecting the LED power supply and circuit boards from additional electrical surges.

Lumecon ETD™ System: The enhanced thermal dissipation system engines are thermally bonded to provide maximum thermal dissipation to the exterior of the fixture to ensure long life. To protect the light engine panel from moisture and corrosion, the LED light engine panel is uniformly coated with a UV stabilized acrylic polymer resin that meets MIL and ASTM dielectric standards, UL, and IPC standards for flammability, moisture resistance and thermal shock.

Certification Data: ETL Listed to UL 1598, UL 8750 for Wet Locations. *Full compliance and test documentation is available for TM-21, LM-79, LM-80, ETL Listing to UL1598 and UL 8750. Salt Fog tested for 3,000 hours per ASTM B117-16 / ASTM D610-08. Ingress Protection: IP66 per ANSI/IEC 60529-2004. Passed 3G vibration @ 100K cycles, per ANSI C136.31-2018.

DesignLights Consortium® (DLC) Qualified Product: Unless noted, not all versions of this product may be DLC® qualified. For a complete list of Lumecon DLC® Qualified Products visit: www.designlights.org.

Dimulator Photo-Control: Maximize the cost-saving benefits of your outdoor LED light fixtures with the stand-alone Dimming solution. All Dimulators (except for CD and DIM 3 versions) have three selectable dimming levels (30%,50%, 70%) with three different start times (10:00 pm, Midnight, or 2:00 am), which are selectable through the ten position selector switch located on the bottom of the base. All dimming schedules will return to full brightness at 5:00 am. The stand-alone unit is made to work with the ANSI C136.41 receptacle and will provide dimming of LED fixtures.

Manufacturing Origin: US Manufactured and Assembled.

BABA Compliant: Meets Build America, Buy America Act Included in the Infrastructure Investment and Jobs Act, Public Law Number 117-58, Title IX, Subtitle A, Part I – Buy America Sourcing Requirements, Sections 70911-70917 stating Manufactured in the U.S. The cost of components mined, produced, or manufactured in the U.S. is greater than 55 percent of the total cost of all manufactured product components.

Warranty: 10 Year L70 performance based warranty. For full warranty terms, please visit our website: www.lumecon.com

Ordering Information

LDS-SFL – Options / Ordering Example: LDS-SFL-110-DB-ST-1-50-SB

| Wattage | Color | Distribution | Voltage | Color Temperature | Mounting Methods |
|-----------------|------------------------|----------------------------|--------------|-------------------|---------------------|
| 30 - 30 Watts | DB - Dark Bronze | ST - Standard ⁸ | 1 - 120-277V | 22 - 2200K | SF - Slip Fitter |
| 45 - 45 Watts | GR - Gray | NR - Narrow ⁸ | 2 - 347-480V | 27 - 2700K | SB - Swivel Bracket |
| 60 - 60 Watts | BK - Black | | | 30 - 3000K | |
| 75 - 75 Watts | WH - White | | | 40 - 4000K | |
| 80 - 80 Watts | CC - Custom Color | | | 50 - 5000K | |
| 85 - 85 Watts | AF - Automotive Finish | | | | |
| 95 - 95 Watts | | | | | |
| 110 - 110 Watts | | | | | |
| 125 - 125 Watts | | | | | |
| 160 - 160 Watts | | | | | |
| 200 - 200 Watts | | | | | |
| 220 - 220 Watts | | | | | |

Options & Accessories

R - Receptacle Only

RS - Receptacle Only with Shorting Cap

7P - Seven-pin Twist Lock Photocell Receptacle Only ¹

PC1 - 120-277V Button Eye Photocell ²

PC2 - 347-480V Button Eye Photocell ²

PC3 - 120-277V Twist Lock Photocell (10 year warranty)

PC4 - 347-480V Twist Lock Photocell (10 year warranty)

OC1 - On/Off ³

OC2 - Dim/High ^{3,4}

OC3 - On/Off w/Photocell ³

OC4 - Dim/High w/Photocell ^{3,4}

SC - Split Circuit ^{5,6,7}

BB - Battery Back-Up (only available on the 30W - 80W models and on 120/277V models)

BBCR - Battery Back-Up Cold Rated (only available on the 30W - 80W models and on 120/277v models)

DIM4 - 105-305 VAC, 50/60 Hz with 10 position field adjustable selector switch

DIM4-HV - High Voltage 312-530 VAC, 50/60 Hz with 10 position field adjustable selector switch

DIM4-CD - Constant all-night Dimming

DIM4-CD-HV - Constant all-night Dimming, 315-530 VAC 50/60Hz

DIM4-CUL - 120 VAC, 50/60 Hz, cUL certified version with gray cover

DIM4-ALC - Adaptive Lighting Control with 2% per year incremental increase to compensate for aging fixture

DIM3-XX - Factory set dimming schedule (10 position selector switch not available)

BS5 - Bird Spikes (Field Installed)

Accessories ordered as a separate line item:

33-00112 - External Glare Shield

33-00120 - Full Glare Snoot

Color Option Samples

Due to variations in monitor settings and color printing settings, colors will not be exact.



DB - DARK
BRONZE

GR - GRAY

BK - BLACK

WH - WHITE

Notes:

- For units with 7P the mounting must be restricted to +/-45° from horizontal aim per ANSI C1136.10-2010. If more than a 45° Tilt, use PC1 or PC2
- Cannot be combined with Occupancy Sensor. Use OC3 or OC4 when Occupancy Sensor and Photocell are needed and aiming greater than 45° from horizontal.
- Must note on PO Mounting Height for proper lens application
- See Occupancy Sensor Default Settings Table
- Split circuit is only available for 30W, 45W, 60W, and 80W models.
- Split circuit is not compatible with Occupancy sensing our photo-eye control.
- Split Circuit and Battery Back-up cannot both fit in the same housing. Battery Back-Up will require external. Battery Backup will only control one of the circuits.
- Standard: NEMA 6x2 and Narrow: NEMA 3x2 (30°)

If OCC Sensor Option is selected, mounting height specifications need to be clarified: Mounting height between 0' - 10'

If Mounting height and parameter settings not specified when ordered. Default mounting height is 10-40' lens and preset factory settings.

- Mounting height between 10' - 20'
 Mounting height over 20'+

OCC Sensor Patterns

0' - 10' Mounting Height

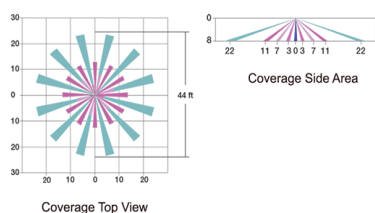

10' - 40' Mounting Height

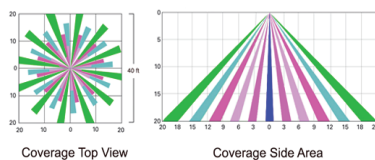

40' + Mounting Height

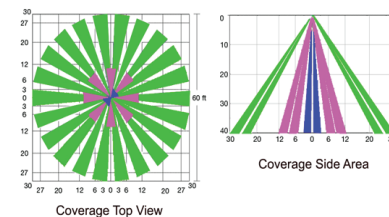

Occupancy Sensor Default Settings - Option OC2

| Option | Dimmed State (Unoccupied) | High Level (When occupied) | Photocell Operation (OC4 Option Only*) | Dwell Time (Occupancy time delay) | Ramp-up Time (From unoccupied to occupied) | Ramp-up Time (From occupied to unoccupied) |
|-------------|---------------------------|----------------------------|--|-----------------------------------|--|--|
| OC2 and OC4 | Approx. 20% Output | 100% Output | Enabled @ 1.5 FC* | 5 Minutes | Disabled | Disabled |

*Note: OC2 and OC4 settings including photocell set point, high/low dim rates, and occupancy sensor time delay are all configurable by using the Wattstopper® App. If any other settings are desired to be set at the factory, please note these changes on Purchase Order.

Performance Data

| Model | 2200K | | 2700K | | 3000K | | 4000K | | 5000K | | | |
|-------------|--------------|-------|--------|----------|--------|----------|--------|----------|--------|----------|--------|----------|
| | Distribution | Watts | Lumens | Efficacy | Lumens | Efficacy | Lumens | Efficacy | Lumens | Efficacy | Lumens | Efficacy |
| LDS-SFL-30 | ST | 30 | 3000 | 100 | 3749 | 131 | 3801 | 133 | 4474 | 151 | 4491 | 151 |
| | NR | 30 | 3120 | 104 | 3879 | 135 | 3933 | 137 | 4474 | 156 | 4644 | 156 |
| LDS-SFL-45 | ST | 45 | 4455 | 99 | 6370 | 142 | 6459 | 144 | 6713 | 149 | 6736 | 150 |
| | NR | 45 | 4635 | 103 | 6591 | 147 | 6683 | 149 | 6941 | 154 | 6966 | 155 |
| LDS-SFL-60 | ST | 60 | 5520 | 92 | 7644 | 128 | 7751 | 130 | 8255 | 138 | 8286 | 138 |
| | NR | 60 | 5700 | 95 | 7909 | 132 | 8020 | 134 | 8538 | 143 | 8580 | 143 |
| LDS-SFL-75 | ST | 75 | 6450 | 86 | 8773 | 112 | 8896 | 118 | 9982 | 132 | 9234 | 122 |
| | NR | 75 | 6675 | 89 | 9077 | 116 | 9204 | 122 | 10322 | 136 | 9573 | 127 |
| LDS-SFL-80 | ST | 80 | 9280 | 116 | 9149 | 112 | 9277 | 114 | 10557 | 129 | 9550 | 116 |
| | NR | 80 | 9680 | 121 | 9467 | 116 | 9599 | 118 | 10916 | 134 | 9908 | 121 |
| LDS-SFL-85 | ST | 85 | 9175 | 107 | 10923 | 131 | 11065 | 133 | 11540 | 138 | 12015 | 145 |
| | NR | 85 | 10285 | 121 | 11161 | 134 | 11303 | 136 | 11790 | 141 | 12277 | 148 |
| LDS-SFL-95 | ST | 95 | 10870 | 127 | 12941 | 138 | 13083 | 140 | 13558 | 145 | 14033 | 150 |
| | NR | 95 | 11070 | 130 | 13179 | 141 | 13321 | 142 | 13808 | 147 | 14295 | 153 |
| LDS-SFL-110 | ST | 110 | 12891 | 117 | 14698 | 133 | 14517 | 132 | 14549 | 133 | 14549 | 133 |
| | NR | 110 | 13093 | 119 | 15197 | 138 | 15010 | 137 | 15044 | 137 | 15044 | 137 |
| LDS-SFL-125 | ST | 125 | 14000 | 112 | 16424 | 131 | 16496 | 131 | 16258 | 130 | 16258 | 130 |
| | NR | 125 | 14476 | 115 | 16983 | 135 | 17057 | 136 | 16824 | 134 | 16824 | 134 |
| LDS-SFL-160 | ST | 160 | 17136 | 109 | 20659 | 131 | 20659 | 131 | 21429 | 137 | 21429 | 137 |
| | NR | 160 | 17718 | 113 | 21353 | 136 | 21652 | 138 | 22149 | 142 | 22149 | 138 |
| LDS-SFL-200 | ST | 200 | 19200 | 96 | 24200 | 121 | 25000 | 125 | 24600 | 123 | 25000 | 125 |
| | NR | 200 | 20200 | 101 | 25200 | 126 | 26000 | 130 | 25600 | 128 | 26000 | 130 |
| LDS-SFL-220 | ST | 220 | 21120 | 96 | 26620 | 121 | 27500 | 125 | 27060 | 123 | 27500 | 125 |
| | NR | 220 | 22220 | 101 | 27720 | 126 | 28600 | 130 | 28160 | 128 | 28600 | 130 |

Mounting Method Dimensions

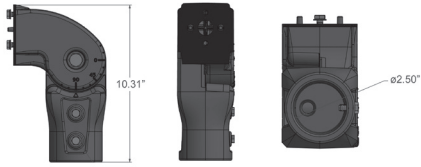

SF - Slip Fitter Arm Dimensions

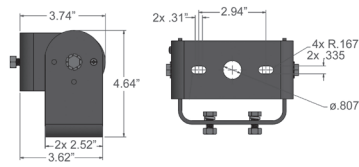

SB - Swivel Bracket Dimensions

External Glare Shield and Full Glare Snoot Dimensions

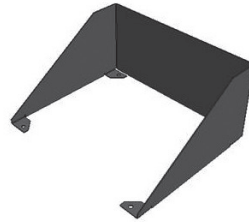
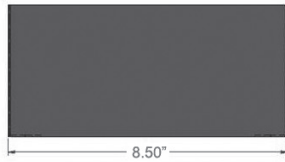
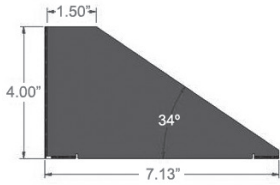

33-00112 – External Glare Shield

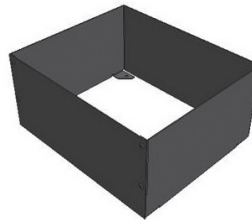
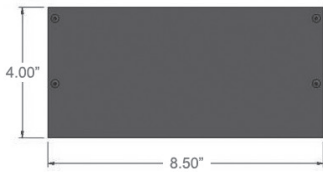

33-00120 – Full Glare Snoot

Performance Data

Electrical Load Data

| Fixture Model | Drive Current (mA) | System Watts (W) | AC Current Load (A) | | | | |
|---------------|--------------------|------------------|---------------------|------|------|------|------|
| | | | 120V | 208V | 240V | 277V | 480V |
| LDS-SFL-30 | 550 | 30 | 0.28 | 0.16 | 0.14 | 0.12 | 0.07 |
| LDS-SFL-45 | 875 | 45 | 0.42 | 0.24 | 0.21 | 0.18 | 0.10 |
| LDS-SFL-60 | 1100 | 60 | 0.56 | 0.32 | 0.28 | 0.24 | 0.14 |
| LDS-SFL-75 | 1475 | 75 | 0.70 | 0.40 | 0.36 | 0.31 | 0.18 |
| LDS-SFL-80 | 1480 | 80 | 0.74 | 0.43 | 0.37 | 0.32 | 0.19 |
| LDS-SFL-85 | 695 | 85 | 0.79 | 0.45 | 0.40 | 0.35 | 0.20 |
| LDS-SFL-95 | 840 | 95 | 0.89 | 0.51 | 0.44 | 0.39 | 0.23 |
| LDS-SFL-110 | 975 | 110 | 1.02 | 0.59 | 0.51 | 0.44 | 0.25 |
| LDS-SFL-125 | 1150 | 125 | 1.16 | 0.67 | 0.58 | 0.50 | 0.29 |
| LDS-SFL-160 | 1450 | 160 | 1.48 | 0.85 | 0.74 | 0.64 | 0.37 |
| LDS-SFL-200 | 1642 | 200 | 1.86 | 1.06 | 0.92 | 0.82 | 0.48 |
| LDS-SFL-220 | 1925 | 220 | 2.05 | 1.17 | 1.00 | 0.90 | 0.53 |

Lumen Maintenance

Data in the table below references projected performance in a 25°C ambient and is based on 10,000 hours of LED testing. Performance data has been tested per IESNA LM-80-08 and projected per IESNA TM-21-11.

Use the lumen maintenance factor that corresponds to the desired number of operating hours below to calculate LLF.

| Fixture Model | Lumen Maintenance Factors @ 25°C, by hours: | | | | |
|---------------|---|--------|--------|--------|---------|
| | 0 | 25,000 | 50,000 | 70,000 | 100,000 |
| LDS-SFL-30 | 1.0 | 0.99 | 0.96 | 0.92 | 0.85 |
| LDS-SFL-45 | 1.0 | 0.99 | 0.96 | 0.92 | 0.85 |
| LDS-SFL-60 | 1.0 | 0.99 | 0.96 | 0.92 | 0.85 |
| LDS-SFL-75 | 1.0 | 0.99 | 0.96 | 0.92 | 0.85 |
| LDS-SFL-80 | 1.0 | 0.99 | 0.96 | 0.92 | 0.85 |
| LDS-SFL-85 | 1.0 | 0.99 | 0.96 | 0.92 | 0.85 |
| LDS-SFL-95 | 1.0 | 0.99 | 0.96 | 0.92 | 0.85 |
| LDS-SFL-110 | 1.0 | 0.99 | 0.96 | 0.92 | 0.85 |
| LDS-SFL-125 | 1.0 | 0.99 | 0.96 | 0.92 | 0.85 |
| LDS-SFL-160 | 1.0 | 0.99 | 0.96 | 0.92 | 0.85 |
| LDS-SFL-200 | 1.0 | 0.99 | 0.96 | 0.92 | 0.85 |
| LDS-SFL-220 | 1.0 | 0.99 | 0.96 | 0.92 | 0.85 |