

PROJECT NAME: _____

CATALOG #: _____

NOTES: _____

DATE: _____

BLS-FLD FLOOD LIGHT

BLS-FLD Flood Light low-profile and stylish exterior design can be well integrated into various architectural environments. Available in four sizes and multiple lumen packages from 15W-120W, this product also achieve up to 150lm/W efficiency. Reliable IP65 structural design, BLS-FLD is very suitable for general flood lighting of courtyards, driveways, buildings, signage, flag poles and billboards.

SPECIFICATIONS FEATURES

Color Temperature Tuning: Capable of delivering 3000K, 4000K & 5000K color temperatures

Construction: Die-cast aluminum optimize the best heat dissipation management as the main part of the fixture, which effectively improves the LED efficiency. Durable surface coating powder spraying and fully sealed tempered glass can extend the durability of the fixture.

Lens: The heat-resistant and impact-resistant toughened glass maximizes light extraction while obtaining a great night appearance.

Installation: 1/2" NPS Knuckle, Slipfitter, Trunnion and Yoke are all available.

Controls: Photocell optional.

CRI: 70

Voltage: 120-277V

Optics: NEMA Type 7 (7H x7V)

Lifespan: Estimated 50,000 Hour based on IES LM-80 results and TM-21 calculations.

Operating Temperature: -40°C to 40°C (-40°F - + 104°F). Note: Operating with emergency battery temperature range: 10°C to 40°C (+50°F - + 104°F)

Power Factor: > 0.90, THD <20%

Listings: cULus, IP66, Suitable for Wet location, RoHS compliant, Meets LM-79 LM-80 Standards. DesignLights Consortium® (DLC) Qualified Product: Unless noted, not all versions of this product may be DLC® qualified. For a complete list of Lumecon DLC® Qualified Products visit: www.designlights.org.

Warranty: 5 year warranty

NOTE- Actual performance may differ as a result of end-user environment and application. All values are design or typical values, measured under laboratory conditions at 25°C(±5°C) specifications subject to change without notice.



ORDERING GUIDE

SAMPLE: BLS-FLD-27-1-ADJ-D-PC-TR-B77

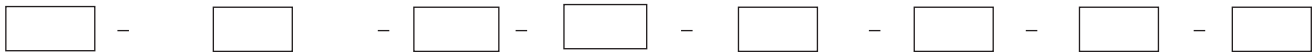

MODEL	WATTAGE	VOLTAGE	CCT	FINISH	PHOTOCELL	MOUNTING	NEMA
BLS-FLD	27 27W, 20W, 15W, 11W	1 120-277V	ADJ Adjustable Color Temperature	D Dark Bronze	PC ¹ 120-277V	TR ² Trunnion	B77 7Hx7V
	CC Custom Color*			KN ² Knuckle			
	*Minimum order of 100 for custom color			YK ³ Yoke			
	120 120W, 98W, 71W, 52W					SP ³ Slipfitter	

NOTE:

1. PC 120-277V Included with Cap if not needed 2. 27W, 65W only suitable for knuckle and trunnion. 3. 120W only suitable for slipfitter and yoke

STRUCTURAL DESIGN

VISOR

All models have an integrated visor that comes with a cover that can reduce glare

OPTICS

A high-reflective white reflector and tempered glass are used to shape NEMA Type 7 (7H x7V)

PHOTOCELL (Option)

Optional photocell allows for security and energy savings



HOUSING

One-piece die-cast aluminum housing with optimal thermal management both enhances LED efficacy and extends fixture's life

MOUNTING

MFD11 have a powerful 1/2 NPS knuckle mount, and also available with either slipfitter or yoke(trunnion) mount



1/2" Knuckle Mount
(27W/65W)



Trunnion Mount
(27W/65W)



Slipfitter Mount
(120W)



Yoke Mount
(120W)

PHOTOMETRICS

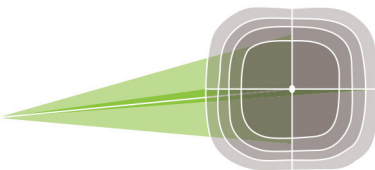

NEMA Type 7 (7H x7V)

PERFORMANCE DATA

SYSTEM WATTS	VOLTAGE	DIST.TYPE	CRI	LUMENS (3000K)	LPW (3000K)	LUMENS (4000K)	LPW (4000K)	LUMENS (5000K)	LPW (5000K)
27W	120-277V	7Hx7V	70	3500lm	130 lm/W	3600lm	133 lm/W	3600lm	133 lm/W
65W	120-277V	7Hx7V	70	9200lm	142 lm/W	9400lm	145 lm/W	9400lm	145 lm/W
120W	120-277V	7Hx7V	70	17500lm	146 lm/W	18000lm	150 lm/W	18000lm	150 lm/W

ELECTRICAL LOAD

Number Of Drivers	Driver Current (mA)	Nominal Power (W)	INPUT VOLTAGE (V)	CURRENT (Amps)
1	450	27	120	0.23
		27	208	0.13
		27	240	0.11
		27	277	0.10
1	980	65	120	0.54
		65	208	0.31
		65	240	0.27
		65	277	0.23
1	960	120	120	1.00
		120	208	0.58
		120	240	0.50
		120	277	0.43

DIMENSIONS

Knuckle Mount
(27W/65W)

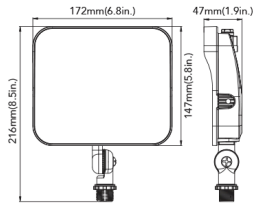

Trunnion Mount
(27W/65W)

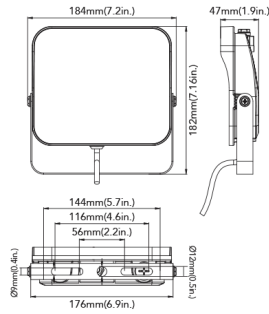

Knuckle Mount
(65W)

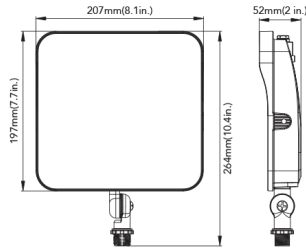

Trunnion Mount
(65W)

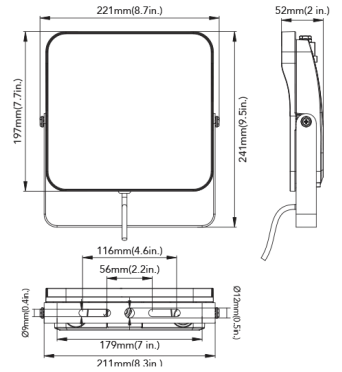

Slipfitter Mount
(120W)

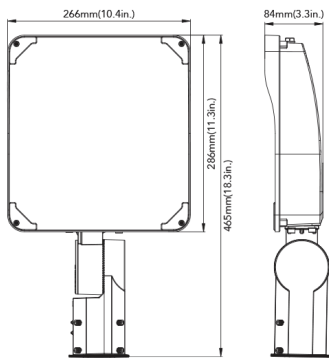

Yoke Mount
(120W)

