



Catalog Number:	
Project:	
Comments:	
Prepared By:	Date:

### Description

The sleek fixture design of the LDS-SFL is a blend of modern sophistication and unmatched energy efficiency. The LDS-SFL small area light includes the benefits of superior thermal efficiency, an industry-leading ten-year all-parts warranty, and custom optics ensuring best-in-class photometric results. Optimize photometric designs with greater pole spacing, uniformity, and lower energy usage. The LDS-SFL includes lumen packages up to 30,000 lumens allowing one-for-one replacements of existing HID fixtures up to 1000 Watt and is a perfect spec-grade solution for parking lots, pathways, tennis courts, and many other outdoor applications. Proudly Made in the USA.

### Dimensions & Weights

Model	Width	Length	Height	Weight
LDS-SFL	13.25"	19.38" (SF) 21.71" (SB)	20.43" (SF) 20.68" (SB)	15 lbs

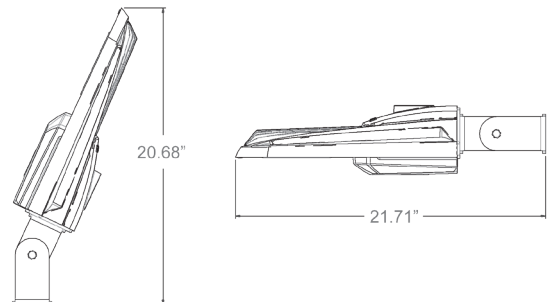
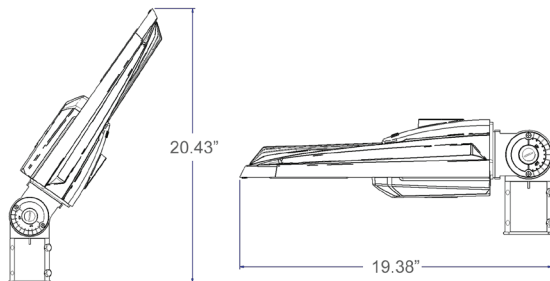

### Technical Specifications

**Input Voltage:** 120-277V or 347-480V.

**Housing:** Die-cast aluminum housing with 60% gloss polyester powder coat finishes for maximum durability. The base aluminum material is prepared using an environmentally-friendly non-chrome 2-step surface cleaning and passivation process. The process results in a more durable conversion layer than traditional chromate conversion coatings and allows maximum adhesion of the powder coating to the aluminum substrate. Housing features an integrated heat sink and driver compartment built into the fixture design.

**Mounting:** Two-piece swivel bracket (standard). Additional mounting options include: slip fitter.

**Split Circuit:** Optional

**Effective Projected Area (EPA):** 1.75 ft<sup>2</sup>

**Color Temperature:** 2200K, 2700K, 3000K, 4000K (standard), 5000K.

**LED Lifetime:** All LEDs are rated for a minimum of 100,000 hours of continuous operation at ambient outdoor temperatures from -40°F/-40°C to 115°F/46°C.

**Color Rendering Index (CRI):** Minimum of 80 or higher. CRI 90+ available upon request. CRI 90+ not available in 2200K.

**Dimming:** 0-10V standard dimming capability.

**Custom Optics:** Lumecon meticulously engineered premium acrylic optical lenses to maximize the distribution and uniformity of light while minimizing cost. Our arrays distribute light at least 21% further and with 29% more uniformity than leading competitors. Lumecon custom lenses create a uniform, well-lit environment that mitigates illuminance "hot spots" and use less wattage than typical LED area lights.

**Vandal Resistant:** Our lens is also resistant to vandalism with a low compact design making the lens material dense and impact resistant. We build to withstand high abuse lighting environments.

**Surge Protection:** Thermally protected 40kV varistor type surge suppressor is included and meets ANSI C136.2-2015: Extreme Level. Also meets IEC61643-11 Class II / EN61643-11 Type 2, and US Dept of Energy MSSLC Model Spec for surge protection. The device is wired in series with the luminaire input power in order to interrupt power to the luminaire when consumed, protecting the LED power supply and circuit boards from additional electrical surges.

**Lumecon ETD™ System:** The enhanced thermal dissipation system engines are thermally bonded to provide maximum thermal dissipation to the exterior of the fixture to ensure long life. To protect the light engine panel from moisture and corrosion, the LED light engine panel is uniformly coated with a UV stabilized acrylic polymer resin that meets MIL and ASTM dielectric standards, UL, and IPC standards for flammability, moisture resistance and thermal shock.

**Certification Data:** ETL Listed to UL 1598, UL 8750 for Wet Locations. \*Full compliance and test documentation is available for TM-21, LM-79, LM-80, ETL Listing to UL1598 and UL 8750. Salt Fog tested for 3,000 hours per ASTM B117-16 / ASTM D610-08. Ingress Protection: IP66 per ANSI/IEC 60529-2004. Passed 3G vibration @ 100K cycles, per ANSI C136.31-2018.

**DesignLights Consortium® (DLC) Qualified Product:** Unless noted, not all versions of this product may be DLC® qualified. For a complete list of Lumecon DLC® Qualified Products visit: [www.designlights.org](http://www.designlights.org).

**Dimulator Photo-Control:** Maximize the cost-saving benefits of your outdoor LED light fixtures with the stand-alone Dimming solution. All Dimulators (except for CD and DIM 3 versions) have three selectable dimming levels (30%, 50%, 70%) with three different start times (10:00 pm, Midnight, or 2:00 am), which are selectable through the ten position selector switch located on the bottom of the base. All dimming schedules will return to full brightness at 5:00 am. The stand-alone unit is made to work with the ANSI C136.41 receptacle and will provide dimming of LED fixtures.

**Manufacturing Origin:** US Manufactured and Assembled.

**Buy American Act:** The product is assembled in the USA and meets the Buy America(n) government procurement requirements under FAR, DFARS, and DOT regulations.

**Warranty:** 10 Year L70 performance based warranty. For full warranty terms, please visit our website: [www.lumecon.com](http://www.lumecon.com)

### Ordering Information

LDS-SFL – Options / Ordering Example: LDS-SFL-110-DB-ST-1-50-SB

Wattage	Color	Distribution	Voltage	Color Temperature	Mounting Methods
30 - 30 Watts	DB - Dark Bronze	ST - Standard <sup>8</sup>	1 - 120-277V	22 - 2200K	SF - Slip Fitter
45 - 45 Watts	GR - Gray	NR - Narrow <sup>8</sup>	2 - 347-480V	27 - 2700K	SB - Swivel Bracket
60 - 60 Watts	BK - Black			30 - 3000K	
75 - 75 Watts	WH - White			40 - 4000K	
80 - 80 Watts	CC - Custom Color			50 - 5000K	
85 - 85 Watts	AF - Automotive Finish				
95 - 95 Watts					
110 - 110 Watts					
125 - 125 Watts					
160 - 160 Watts					
200 - 200 Watts					
220 - 220 Watts					

### Options & Accessories

R - Receptacle Only

RS - Receptacle Only with Shorting Cap

7P - Seven-pin Twist Lock Photocell Receptacle Only <sup>1</sup>

PC1 - 120-277V Button Eye Photocell <sup>2</sup>

PC2 - 347-480V Button Eye Photocell <sup>2</sup>

PC3 - 120-277V Twist Lock Photocell (10 year warranty)

PC4 - 347-480V Twist Lock Photocell (10 year warranty)

OC1 - On/Off <sup>3</sup>

OC2 - Dim/High <sup>3,4</sup>

OC3 - On/Off w/Photocell <sup>3</sup>

OC4 - Dim/High w/Photocell <sup>3,4</sup>

SC - Split Circuit <sup>5,6,7</sup>

BB - Battery Back-Up (only available on the 30W - 80W models and on 120/277V models)

BBCR - Battery Back-Up Cold Rated (only available on the 30W - 80W models and on 120/277v models)

DIM4 - 105-305 VAC, 50/60 Hz with 10 position field adjustable selector switch

DIM4-HV - High Voltage 312-530 VAC, 50/60 Hz with 10 position field adjustable selector switch

DIM4-CD - Constant all-night Dimming

DIM4-CD-HV - Constant all-night Dimming, 315-530 VAC 50/60Hz

DIM4-CUL - 120 VAC. 50/60 Hz, cUL certified version with gray cover

DIM4-ALC - Adaptive Lighting Control with 2% per year incremental increase to compensate for aging fixture

DIM3-XX - Factory set dimming schedule (10 position selector switch not available)

BS5 - Bird Spikes (Field Installed)

### Accessories ordered as a separate line item:

33-00112 - External Glare Shield

33-00120 - Full Glare Snoot

### Color Option Samples

*Due to variations in monitor settings and color printing settings, colors will not be exact.*



DB - DARK  
BRONZE

GR - GRAY

BK - BLACK

WH - WHITE

#### Notes:

- For units with 7P the mounting must be restricted to +/-45° from horizontal aim per ANSI C1136.10-2010. If more than a 45° Tilt, use PC1 or PC2
- Cannot be combined with Occupancy Sensor. Use OC3 or OC4 when Occupancy Sensor and Photocell are needed and aiming greater than 45° from horizontal.
- Must note on PO Mounting Height for proper lens application
- See Occupancy Sensor Default Settings Table
- Split circuit is only available for 30W, 45W, 60W, and 80W models.
- Split circuit is not compatible with Occupancy sensing our photo-eye control.
- Split Circuit and Battery Back-up cannot both fit in the same housing. Battery Back-Up will require external. Battery Backup will only control one of the circuits.
- Standard: NEMA 7x7 and Narrow: NEMA 4x4

If OCC Sensor Option is selected, mounting height specifications need to be clarified:  Mounting height between 0' - 10'

If Mounting height and parameter settings not specified when ordered. Default mounting height is 10-40' lens and preset factory settings.

- Mounting height between 10' - 20'
- Mounting height over 20'+

### OCC Sensor Patterns

0' - 10' Mounting Height

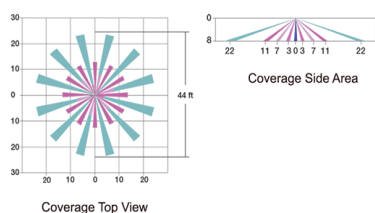

10' - 40' Mounting Height

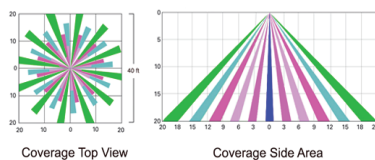

40' + Mounting Height

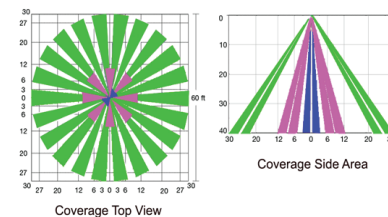

### Occupancy Sensor Default Settings - Option OC2

Option	Dimmed State (Unoccupied)	High Level (When occupied)	Photocell Operation (OC4 Option Only*)	Dwell Time (Occupancy time delay)	Ramp-up Time (From unoccupied to occupied)	Ramp-up Time (From occupied to unoccupied)
OC2 and OC4	Approx. 20% Output	100% Output	Enabled @ 1.5 FC*	5 Minutes	Disabled	Disabled

\*Note: OC2 and OC4 settings including photocell set point, high/low dim rates, and occupancy sensor time delay are all configurable by using the Wattstopper® App. If any other settings are desired to be set at the factory, please note these changes on Purchase Order.

### Performance Data

Model			2200K		2700K		3000K		4000K		5000K	
	Distribution	Watts	Lumens	Efficacy	Lumens	Efficacy	Lumens	Efficacy	Lumens	Efficacy	Lumens	Efficacy
LDS-SFL-30	ST	30	3000	100	3749	131	3801	133	4474	151	4491	151
	NR	30	3120	104	3879	135	3933	137	4474	156	4644	156
LDS-SFL-45	ST	45	4455	99	6370	142	6459	144	6713	149	6736	150
	NR	45	4635	103	6591	147	6683	149	6941	154	6966	155
LDS-SFL-60	ST	60	5520	92	7644	128	7751	130	8255	138	8286	138
	NR	60	5700	95	7909	132	8020	134	8538	143	8580	143
LDS-SFL-75	ST	75	6450	86	8773	112	8896	118	9982	132	9234	122
	NR	75	6675	89	9077	116	9204	122	10322	136	9573	127
LDS-SFL-80	ST	80	9280	116	9149	112	9277	114	10557	129	9550	116
	NR	80	9680	121	9467	116	9599	118	10916	134	9908	121
LDS-SFL-85	ST	85	9175	107	10923	131	11065	133	11540	138	12015	145
	NR	85	10285	121	11161	134	11303	136	11790	141	12277	148
LDS-SFL-95	ST	95	10870	127	12941	138	13083	140	13558	145	14033	150
	NR	95	11070	130	13179	141	13321	142	13808	147	14295	153
LDS-SFL-110	ST	110	12891	117	14698	133	14517	132	14549	133	14549	133
	NR	110	13093	119	15197	138	15010	137	15044	137	15044	137
LDS-SFL-125	ST	125	14000	112	16424	131	16496	131	16258	130	16258	130
	NR	125	14476	115	16983	135	17057	136	16824	134	16824	134
LDS-SFL-160	ST	160	17136	109	20659	131	20659	131	21429	137	21429	137
	NR	160	17718	113	21353	136	21652	138	22149	142	22149	138
LDS-SFL-200	ST	200	19200	96	24200	121	25000	125	24600	123	25000	125
	NR	200	20200	101	25200	126	26000	130	25600	128	26000	130
LDS-SFL-220	ST	220	21120	96	26620	121	27500	125	27060	123	27500	125
	NR	220	22220	101	27720	126	28600	130	28160	128	28600	130

**Mounting Method Dimensions**

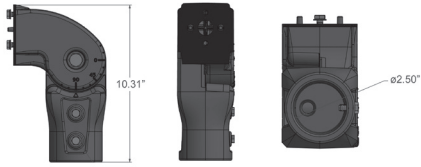

SF - Slip Fitter Arm Dimensions

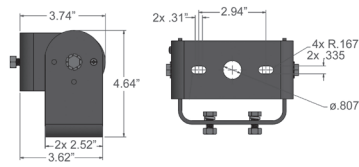

SB - Swivel Bracket Dimensions

**External Glare Shield and Full Glare Snoot Dimensions**

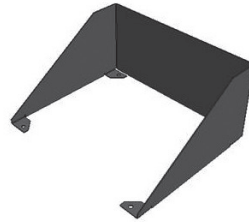
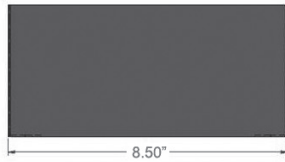
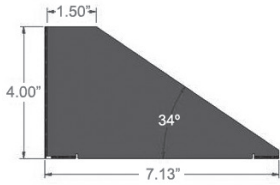

33-00112 – External Glare Shield

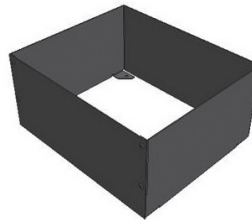
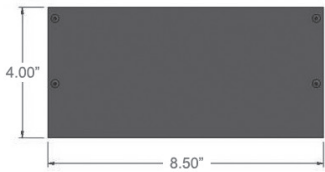

33-00120 – Full Glare Snoot

### Performance Data

#### Electrical Load Data

Fixture Model	Drive Current (mA)	System Watts (W)	AC Current Load (A)				
			120V	208V	240V	277V	480V
LDS-SFL-30	550	30	0.28	0.16	0.14	0.12	0.07
LDS-SFL-45	875	45	0.42	0.24	0.21	0.18	0.10
LDS-SFL-60	1100	60	0.56	0.32	0.28	0.24	0.14
LDS-SFL-75	1475	75	0.70	0.40	0.36	0.31	0.18
LDS-SFL-80	1480	80	0.74	0.43	0.37	0.32	0.19
LDS-SFL-85	695	85	0.79	0.45	0.40	0.35	0.20
LDS-SFL-95	840	95	0.89	0.51	0.44	0.39	0.23
LDS-SFL-110	975	110	1.02	0.59	0.51	0.44	0.25
LDS-SFL-125	1150	125	1.16	0.67	0.58	0.50	0.29
LDS-SFL-160	1450	160	1.48	0.85	0.74	0.64	0.37
LDS-SFL-200	1642	200	1.86	1.06	0.92	0.82	0.48
LDS-SFL-220	1925	220	2.05	1.17	1.00	0.90	0.53

#### Lumen Maintenance

Data in the table below references projected performance in a 25°C ambient and is based on 10,000 hours of LED testing. Performance data has been tested per IESNA LM-80-08 and projected per IESNA TM-21-11.

Use the lumen maintenance factor that corresponds to the desired number of operating hours below to calculate LLF.

Fixture Model	Lumen Maintenance Factors @ 25°C, by hours:				
	0	25,000	50,000	70,000	100,000
LDS-SFL-30	1.0	0.99	0.96	0.92	0.85
LDS-SFL-45	1.0	0.99	0.96	0.92	0.85
LDS-SFL-60	1.0	0.99	0.96	0.92	0.85
LDS-SFL-75	1.0	0.99	0.96	0.92	0.85
LDS-SFL-80	1.0	0.99	0.96	0.92	0.85
LDS-SFL-85	1.0	0.99	0.96	0.92	0.85
LDS-SFL-95	1.0	0.99	0.96	0.92	0.85
LDS-SFL-110	1.0	0.99	0.96	0.92	0.85
LDS-SFL-125	1.0	0.99	0.96	0.92	0.85
LDS-SFL-160	1.0	0.99	0.96	0.92	0.85
LDS-SFL-200	1.0	0.99	0.96	0.92	0.85
LDS-SFL-220	1.0	0.99	0.96	0.92	0.85