

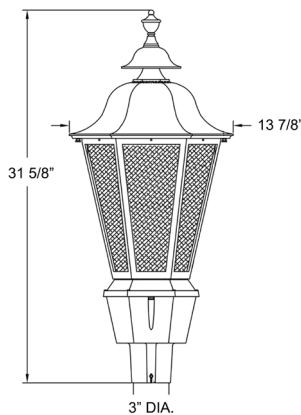

Shown with:  
H5534BP Style  
Antique Copper Finish  
CL - Clear Acrylic Lens



H5534BP Style  
H: 31 5/8"  
W: 13 7/8"  
EPA: 1.30  
Fitter: 3" Diameter

### Technical Specifications

**HOUSING:** Slip fits over 2 7/8" and 3" OD tenons on most decorative poles. Cast aluminum housing uses A356 aluminum comprises 92.05% Aluminum, 7% Silicon, 0.35% Magnesium, 0.20% Iron, 0.20% Copper, 0.10% Manganese, and 0.10% Zinc. It is lightweight and highly corrosion-resistant, like stainless steel. Heat treated to improve strength—low impurities cause high strength and ductility.

**FINISH:** Cast aluminum fitter housing with textured or 60% gloss polyester powder coat finishes for maximum durability. The base aluminum material is prepared using an environmentally friendly non-chrome 2-step surface cleaning and passivation process. The process results in a more durable conversion layer than traditional chromate conversion coatings and allows maximum powder coating adhesion to the aluminum fitter.

#### POWERED BY THE LUMECON L-RETRO-T LIGHT ENGINE

**INPUT VOLTAGE:** 120-277V or 347-480V

**EFFECTIVE PROJECTED AREA (EPA):** 1.3 ft<sup>2</sup>

**CUSTOM OPTICS:** Lumecon meticulously engineered premium acrylic optical lenses to maximize the distribution and uniformity of light while minimizing cost. Our arrays distribute light at least 21% further and with 29% more uniformity than leading competitors. Lumecon custom lenses create a uniform, well-lit environment that mitigates illuminance "hot spots" and uses less wattage than typical LED area lights.



L-RETRO-T  
Light Engine

**LUMECON ETD™ SYSTEM:** The enhanced thermal dissipation system engines are thermally bonded to provide maximum thermal dissipation to the fixture's exterior to ensure long life. To protect the light engine panel from moisture and corrosion, the LED light engine panel is uniformly coated with a UV-stabilized acrylic polymer resin that meets MIL and ASTM dielectric standards, UL, and IPC standards for flammability, moisture resistance, and thermal shock.

**COLOR TEMPERATURE:** 2200K, 2700K, 3000K, 4000K, and 5000K.

**LED LIFETIME:** All LEDs are rated for a minimum of 100,000 hours of continuous operation at ambient temperatures from -40°F/-40°C to 115°F/46°C.

**COLOR RENDERING INDEX (CRI):** Minimum of 80 or higher. CRI 90+ is available upon request. CRI 90+ is not available in 2200K.

**DIMMING:** 0-10V standard dimming capability.

**SURGE PROTECTION:** Thermally protected 20kA/ 40kV varistor type surge suppressor is included and meets ANSI C136.2- 2015: Extreme Level. It also meets IEC61643-11 Class II / EN61643-11 Type 2 and US Dept of Energy MSSLC Model Spec for surge protection. The device is wired in series with the luminaire input power to interrupt power to the luminaire when consumed, protecting the LED power supply and circuit boards from additional electrical surges.

**MANUFACTURING ORIGIN:** US Manufactured and Assembled.

**BUY AMERICAN ACT:** The product is assembled in the USA and meets the Buy America(n) government procurement requirements under FAR, DFARS, and DOT regulations.

**DESIGNLIGHTS CONSORTIUM® (DLC) QUALIFIED PRODUCT:** Unless noted, not all versions of this product may be DLC® qualified. For a complete list of Lumecon DLC® Qualified Products visit: [www.designlights.org](http://www.designlights.org).

**CERTIFICATION:** Manufactured with ETL-compliant components.

**WARRANTY:** 10 Year L70 performance-based warranty. For full warranty terms, please visit our website: [www.lumecon.com](http://www.lumecon.com).



L-RETRO-T  
LIGHT ENGINE

**PERFORMANCE DATA**

Model	Distribution Type	Watts	2200K		2700K		3000K		4000K		5000K	
			Lumens	Efficacy	Lumens	Efficacy	Lumens	Efficacy	Lumens	Efficacy	Lumens	Efficacy
LM-MDN	Type 2	20W	2,001	100	2,470	124	2,503	125	2,792	140	2,792	140
	Type 3	20W	2,062	103	2,546	127	2,579	129	2,877	144	2,877	144
	Type 4	20W	1,969	98	2,431	122	2,463	123	2,747	137	2,747	137
	Type 5	20W	1,972	99	2,435	122	2,467	123	2,747	138	2,747	138
LM-MDN	Type 2	40W	4,120	103	5,087	127	5,150	129	5,712	143	5,712	143
	Type 3	40W	4,142	104	5,114	128	5,177	129	5,743	144	5,743	144
	Type 4	40W	4,109	103	5,073	127	5,135	128	5,696	142	5,696	142
	Type 5	40W	4,110	103	5,074	127	5,137	128	5,697	142	5,697	142
LM-MDN	Type 2	60W	6,084	101	7,511	125	7,604	127	8,448	141	8,448	141
	Type 3	60W	6,117	102	7,552	126	7,646	127	8,494	142	8,494	142
	Type 4	60W	6,066	101	7,489	125	7,583	126	8,424	140	8,424	140
	Type 5	60W	6,068	101	7,491	125	7,585	126	8,426	140	8,426	140

**ORDERING INFORMATION**

Lumecon Midtown Post-Top Series

Example Part Number: LM-MDN-H5534BP-40-1-40-T3-NL-BLK-PC-BL

REQUIRED								OPTIONAL		
MODEL	STYLE	WATTAGE	VOLTAGE	CCT	DISTRIBUTION	LENS	FINISH	PHOTOCELL	HOUSE SIDE SHIELD	DIMMING CONTROLS
LM-MDN	H4110WA	20 - 20 Watts	1 - 120v - 277v	22 - 2200K	T2 - Type II	NL - No Lens	See Samples on next page	PC - Button Eye	BL - Back Light Louvers	FAWS - Field Adjustable Wattage Selector
	H5110WA	40 - 40 Watts	2 - 347v - 480v	27 - 2700K	T3 - Type III	CA - Clear Acrylic				
	H5534BP	60 - 60 Watts		30 - 3000K	T4 - Type IV	OA - Opal Acrylic				
	H6034BP			40 - 4000K	T5 - Type V	PP - Prismatic Polycarbonate				
	H6010WA			50 - 5000K						
	H9410WA									
	H9434BP									

**Available Finishes**

Standard



Premium

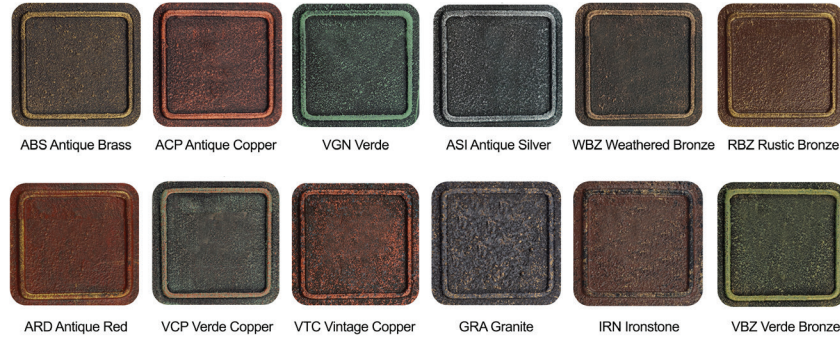

**Product Style Samples**

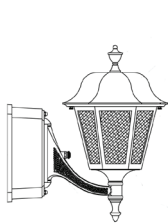

**H4110WA**  
H: 19 3/4"  
W: 11 3/4"  
Proj: 15 3/4"  
T/O: 12 1/2"

Only Available in  
20W and 40W

To view specific details,  
[download here](#)

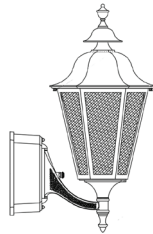

**H5510WA**  
H: 29 7/8"  
W: 14"  
Proj: 17"  
T/O: 22 1/4"

To view specific details,  
[download here](#)



**H5534BP**  
H: 31 5/8"  
W: 13 7/8"  
EPA: 1.30  
Fitter: 3" Dia.

To view specific details,  
[download here](#)

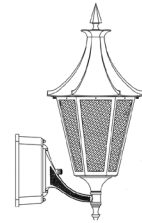

**H6010WA**  
H: 32 7/8"  
W: 14 5/8"  
Proj: 17 1/4"  
T/O: 25 1/4"

To view specific details,  
[download here](#)



**H6034BP**  
H: 34 3/4"  
W: 14 1/2"  
EPA: 1.35  
Fitter: 3" Dia.

To view specific details,  
[download here](#)

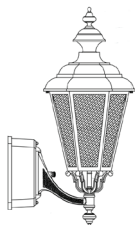

**H9410WA**  
H: 32 7/8"  
W: 13 5/8"  
Proj: 18 3/8"  
T/O: 24 5/8"

To view specific details,  
[download here](#)

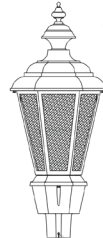

**H9434BP**  
H: 33 1/4"  
W: 13 3/4"  
EPA: 1.35  
Fitter: 3" Dia.

To view specific details,  
[download here](#)

## OPTIONAL BASE AND POLE ORDERING INFORMATION

POLE OPTIONS	DECORATIVE BASE OPTIONS
X - None	X - None
H-RSA - Round Straight Aluminum	Arlen-13
H-RTA - Round Tapered Aluminum	Arlen-17
H-RFA - Round Fluted Aluminum	York-17
	Homewood
For additional Options click here: <a href="#">Pole Options</a>	For additional Options click here: <a href="#">Decorative Base Options</a>

### Decorative Bases Ordering Information

Over 58 Base options available. The most popular listed below. [To view all options, download Base guide here.](#)

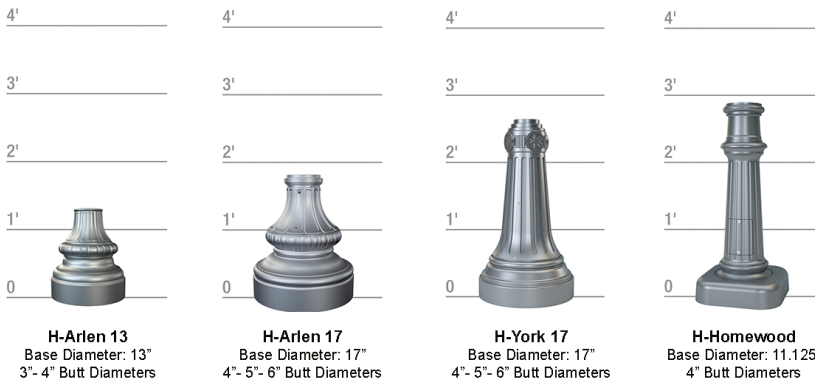

### Pole Ordering Information

#### Pole Ordering Example: H-RTA30D8B4-01

*Rounded Tapered Aluminum, 30' Mounting Height, .188" Wall Thickness, 8" Butt Diameter, 4.5" Top Diameter, 4-Bolt Base, Satin Aluminum Finish*

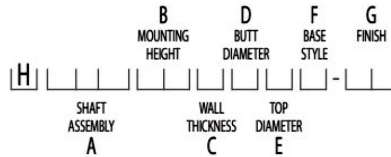

#### A General Assembly

H-RSA - Round Straight Aluminum  
H-RTA - Round Tapered Aluminum  
H-RFA - Round Fluted Aluminum

#### B Mounting Heights

08 - 8"    14 - 14"    20 - 20"  
10 - 10"    16 - 16"    25 - 25"  
12 - 12"    18 - 18"    30 - 30"

#### C Wall Thickness

B - 0.125"    F - 0.250"  
C - 0.156"    G - 0.312"  
D - 0.188"    H - 0.375"  
E - 0.219"

#### D Butt Diameter

1 - 10"    5 - 5"    7 - 7"  
2 - 12"    6 - 6"    8 - 8"  
4 - 4"    J - 6.625    9 - 9"

#### E Top Diameter

A - 3"  
B - 4.5"  
C - 6"

#### F Base Style

3 - 3-Bolt Anchor Base  
4 - 4-Bolt Anchor Base  
V - Bee Hive Base  
H - Hinged Anchor Base  
E - Direct Buried (Embed)  
F - Breakaway Transformer Base

#### G Finish

01 - Satin Aluminum (RTA and RSA)  
02 - Satin Aluminum (SSA)  
BA - Black Powder Coat  
BH - White Powder Coat  
BM - Dark Bronze Powder Coat  
BV - Dark Green Powder Coat  
GC - Gray Powder Coat  
.. - Specify Finish

For additional Options, download [Pole Guide Here](#)