



Catalog Number:	
Project:	
Comments:	
Prepared By:	Date:

Description

The sleek fixture design of the LDS-SAL is a blend of modern sophistication and unmatched energy efficiency. The LDS-SAL small area light includes the benefits of superior thermal efficiency, an industry-leading ten-year all-parts warranty, and custom optics ensuring best-in-class photometric results. Optimize photometric designs with greater pole spacing, uniformity, and lower energy usage. The LDS-SAL includes lumen packages up to 30,000 lumens allowing one-for-one replacements of existing HID fixtures up to 1000 Watt and is a perfect spec-grade solution for parking lots, pathways, tennis courts, and many other outdoor applications. Proudly Made in the USA.

Technical Specifications

Input Voltage: 120-277V or 347-480V.

Housing: Die-cast aluminum housing with 60% gloss polyester powder coat finishes for maximum durability. The base aluminum material is prepared using an environmentally-friendly non-chrome 2-step surface cleaning and passivation process. The process results in a more durable conversion layer than traditional chromate conversion coatings and allows maximum adhesion of the powder coating to the aluminum substrate. Housing features an integrated heat sink and driver compartment built into the fixture design.

Mounting: Mounting arm designed for a square / round pole (standard). Additional mounting options include a pole mounting arm adaptor.

Split Circuit: Optional

Effective Projected Area (EPA): 0.83 ft²

Color Temperature: 2200K, 2700K, 3000K, 4000K (standard), 5000K.

LED Lifetime: All LEDs are rated for a minimum of 100,000 hours of continuous operation at ambient outdoor temperatures from -40°F/-40°C to 115°F/46°C.

Color Rendering Index (CRI): Minimum of 80 or higher. CRI 90+ available upon request. CRI 90+ not available in 2200K.

Dimming: 0-10V standard dimming capability.

Custom Optics: Lumecon meticulously engineered premium acrylic optical lenses to maximize the distribution and uniformity of light while minimizing cost. Our arrays distribute light at least 21% further and with 29% more uniformity than leading competitors. Lumecon custom lenses create a uniform, well-lit environment that mitigates illuminance "hot spots" and use less wattage than typical LED area lights.

Vandal Resistant: Our lens is also resistant to vandalism with a low compact design making the lens material dense and impact resistant. We build to withstand high abuse lighting environments.

Surge Protection: Thermally protected 20kA/ 40kV varistor type surge suppressor is included and meets ANSI C136.2-2015: Extreme Level. Also meets IEC61643-11 Class II / EN61643-11 Type 2, and US Dept of Energy MSSLC Model Spec for surge protection. The device is wired in series with the luminaire input power in order to interrupt power to the luminaire when consumed, protecting the LED power supply and circuit boards from additional electrical surges.

Lumecon ETD™ System: The enhanced thermal dissipation system engines are thermally bonded to provide maximum thermal dissipation to the exterior of the fixture to ensure long life. To protect the light engine panel from moisture and corrosion, the LED light engine panel is uniformly coated with a UV stabilized acrylic polymer resin that meets MIL and ASTM dielectric standards, UL, and IPC standards for flammability, moisture resistance and thermal shock.

Certification Data: ETL Listed to UL 1598, UL 8750 Wet Locations. *Full compliance and test documentation is available for TM-21, LM-79, LM-80, ETL Listing to UL1598 and UL 8750.Salt Fog tested for 3,000 hours per ASTM B117-16 / ASTM D610-08. Ingress Protection: IP66 per ANSI/IEC 60529-2004. Passed 3G vibration @ 100K cycles, per ANSI C136.31-2018.

DesignLights Consortium® (DLC) Qualified Product: Unless noted, not all versions of this product may be DLC® qualified. For a complete list of Lumecon DLC® Qualified Products visit: www.designlights.org.

Dimulator Photo-Control: Maximize the cost-saving benefits of your outdoor LED light fixtures with the stand-alone Dimming solution. All Dimulators (except for CD and DIM 3 versions) have three selectable dimming levels (30%,50%, 70%) with three different start times (10:00 pm, Midnight, or 2:00 am), which are selectable through the ten position selector switch located on the bottom of the base. All dimming schedules will return to full brightness at 5:00 am. The stand-alone unit is made to work with the ANSI C136.41 receptacle and will provide dimming of LED fixtures.

Manufacturing Origin: US Manufactured and Assembled.

Buy American Act: The product is assembled in the USA and meets the Buy America(n) government procurement requirements under FAR, DFARS, and DOT regulations.

BABA Compliant: Meets Build America, Buy America Act Included in the Infrastructure Investment and Jobs Act, Public Law Number 117-58, Title IX, Subtitle A, Part I – Buy America Sourcing Requirements, Sections 70911-70917 stating Manufactured in the U.S. The cost of components mined, produced, or manufactured in the U.S. is greater than 55 percent of the total cost of all manufactured product components.

Warranty: 10 Year L70 performance based warranty. For full warranty terms, please visit our website: www.lumecon.com

Ordering Information

LDS-SAL – Options / Ordering Example: LDS-SAL-110-DB-T5-1-50-MAS

Wattage	Color	Distribution	Voltage	Color Temperature	Mounting Methods
30 - 30 Watts	DB - Dark Bronze	T2 - Type II	1 - 120v-277v	22 - 2200K ⁸	MAS - Mounting Arm (Square Pole) ⁸ <i>For a Round pole, add UARP option</i>
45 - 45 Watts	GR - Gray	T3 - Type III	2 - 347v-480v	27 - 2700K ⁸	SF - Slip Fitter
60 - 60 Watts	BK - Black	T4 - Type IV		30 - 3000K ⁸	TM - Tenon Mount ⁸
75 - 75 Watts	WH - White	T5 - Type V		40 - 4000K	
80 - 80 Watts	CC - Custom Color			50 - 5000K	
85 - 85 Watts	AF - Automotive Finish				
95 - 95 Watts					
110 - 110 Watts					
125 - 125 Watts					
160 - 160 Watts					
200 - 200 Watts					
220 - 220 Watts					

Options & Accessories

UARP - Universal Adaptor Round Pole

R - Receptacle Only

RS - Receptacle Only with Shorting Cap

7P - Seven-pin Twist Lock Photocell Receptacle Only ¹

PC1 - 120v-277v Button Eye Photocell ²

PC2 - 347v-480v Button Eye Photocell ²

PC3 - 120v-277v Twist Lock Photocell (10 year warranty)

PC4 - 347v-480v Twist Lock Photocell (10 year warranty)

OC1 - On/Off ³

OC2 - Dim/High ^{3,4}

OC3 - On/Off w/Photocell ³

OC4 - Dim/High w/Photocell ^{3,4}

SC - Split Circuit ^{5,6,7}

BB - Battery Back-Up (only available on the 30W - 80W models and on 120/277V models)

BBCR - Battery Back-Up Cold Rated (only available on the 30W - 80W models and on 120/277v models)

DIM4 - 105-305 VAC, 50/60 Hz with 10 position field adjustable selector switch with integrated photocell

DIM4-HV - High Voltage 312-530 VAC, 50/60 Hz with 10 position field adjustable selector switch with integrated photocell

DIM4-CD - Constant all-night Dimming with integrated photocell

DIM4-CD-HV - Constant all-night Dimming, 315-530 VAC 50/60Hz with integrated photocell

DIM4-CUL - 120 VAC. 50/60 Hz, cUL certified version with gray cover with integrated photocell

DIM4-ALC - Adaptive Lighting Control with 2% per year incremental increase to compensate for aging fixture with integrated photocell

DIM3-XX - Factory set dimming schedule (10 position selector switch not available) with integrated photocell

BS5 - Bird Spikes (Field Installed)

BL - Backlight Louver(s) snap over LED Array(s) for Backlight Control at the source. ⁹
Accessories ordered as a separate line item:

33-00112 - External Glare Shield

33-00120 - Full Glare Snoot

Notes:

- For units with 7P the mounting must be restricted to +/-45° from horizontal aim per ANSI C1136.10-2010. If more than a 45° Tilt, use PC1 or PC2
- Cannot be combined with Occupancy Sensor. Use OC3 or OC4 when Occupancy Sensor and Photocell are needed and aiming greater than 45° from horizontal.
- Must note on PO Mounting Height for proper lens application
- See Occupancy Sensor Default Settings Table
- Split circuit is only available for 30W, 45W, 60W, and 80W models.
- Split circuit is not compatible with Occupancy sensing our photo-eye control.
- Split Circuit and Battery Back-up cannot both fit in the same housing. Battery Back-Up will require external. Battery Backup will only control one of the circuits.
- 3000K or warmer, and fixed mounts must be ordered for IDA certification compliance.
- Works with Type 2, Type 3 and Type 4 arrays.

If OCC Sensor Option is selected, mounting height specifications need to be clarified:

- Mounting height between 0' - 10'
- Mounting height between 10' - 20'
- Mounting height over 20'+

If Mounting height and parameter settings not specified when ordered. Default mounting height is 10-40' lens and preset factory settings.

OCC Sensor Patterns

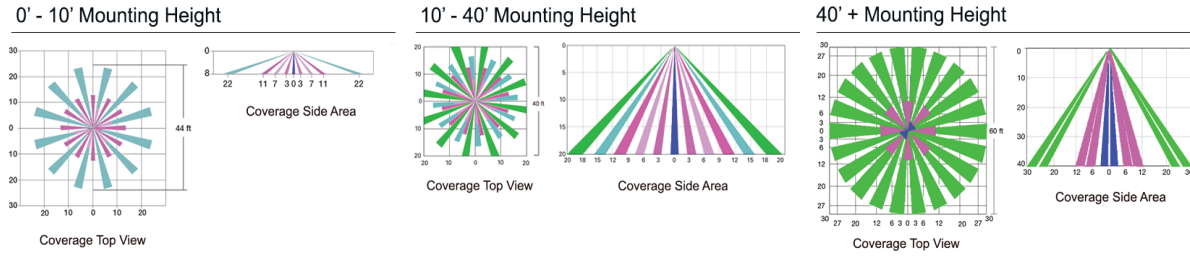

Occupancy Sensor Default Settings - Option OC2

Option	Dimmed State (Unoccupied)	High Level (When occupied)	Photocell Operation (OC4 Option Only*)	Dwell Time (Occupancy time delay)	Ramp-up Time (From unoccupied to occupied)	Ramp-up Time (From occupied to unoccupied)
OC2 and OC4	Approx. 20% Output	100% Output	Enabled @ 1.5 FC*	5 Minutes	Disabled	Disabled

*Note: OC2 and OC4 settings including photocell set point, high/low dim rates, and occupancy sensor time delay are all configurable by using the Wattstopper® App. If any other settings are desired to be set at the factory, please note these changes on Purchase Order.

Dimensions & Weights

Model	Width	Length	Height	Weight
LDS-SAL	13.25"	19.25"	4.35" 6.70" (MAS) 10.72" (SF)	15 lbs

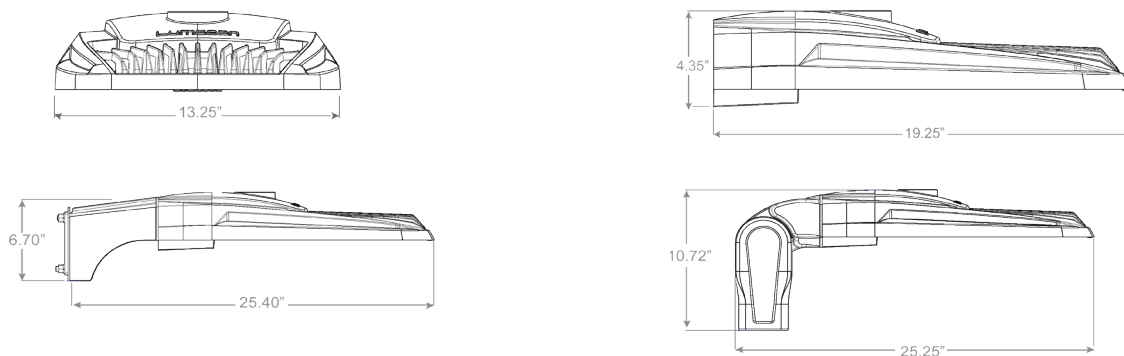

Color Option Samples

Due to variations in monitor settings and color printing settings, colors will not be exact.



Mounting Method Dimensions

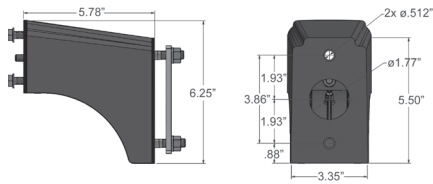

MAS - Square Pole Arm Dimensions

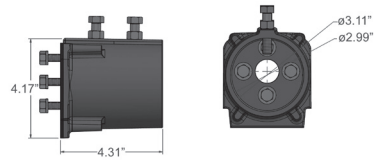

TM - Tenon Arm Dimensions

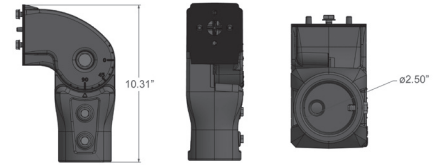

SF - Slip Fitter Arm Dimensions

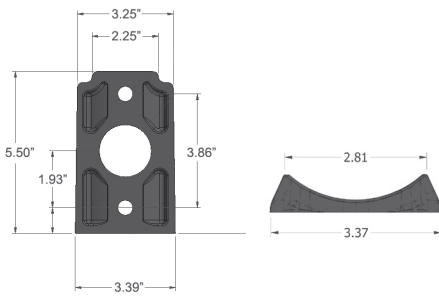

UARP - Universal Adaptor Round Pole

External Glare Shield and Full Glare Snoot Dimensions

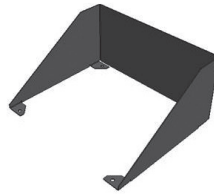
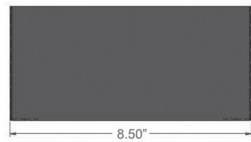
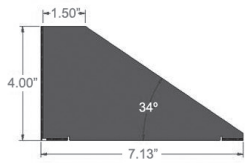

Field Installed for Forward Glare Reduction



Field Installed for Rear Glare Reduction

33-00112 – External Glare Shield

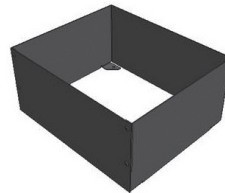
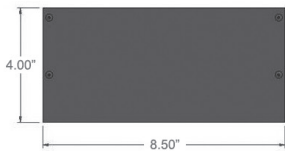

33-00120 – Full Glare Snoot

Backlight Louver(s)



BL - Backlight Louver(s) snap over LED Array(s) for Backlight Control at the source.
Works with Type 2, Type 3 and Type 4 arrays.

Performance Data

Model	Distribution Type	Watts	2200K				2700K				3000K				4000K				5000K								
			Lumens	B	U	G	Efficacy	Lumens	B	U	G	Efficacy	Lumens	B	U	G	Efficacy	Lumens	B	U	G	Efficacy	Lumens	B	U	G	Efficacy
LDS-SAL/LFC-30	Type 2	30	3,267	1	0	1	109	4,367	1	0	1	146	4,400	1	0	1	147	4,900	1	0	1	163	4,933	1	0	1	164
	Type3	30	3,300	1	0	1	110	4,400	1	0	1	147	4,433	1	0	1	148	4,967	1	0	1	166	4,967	1	0	1	166
	Type4	30	3,233	1	0	1	108	4,300	1	0	1	143	4,367	1	0	1	146	4,867	1	0	1	162	4,900	1	0	1	163
	Type5	30	3,333	2	0	2	111	4,367	2	0	2	146	4,433	2	0	2	148	5,033	2	0	2	168	5,033	2	0	2	168
	Type2	45	5,150	1	0	1	114	7,350	1	0	1	163	7,450	1	0	1	166	7,700	1	0	1	171	7,750	1	0	1	172
LDS-SAL/LFC-45	Type3	45	4,850	1	0	1	108	7,050	1	0	1	157	7,150	1	0	1	159	7,300	1	0	1	162	7,300	1	0	1	162
	Type4	45	4,800	1	0	1	107	6,850	1	0	1	152	6,950	1	0	1	154	7,250	1	0	1	161	7,250	1	0	1	161
	Type5	45	4,950	3	0	2	110	7,100	3	0	2	158	7,200	3	0	2	160	7,450	3	0	2	166	7,500	3	0	2	167
	Type2	60	6,000	1	0	2	100	8,467	1	0	2	141	8,667	1	0	2	144	9,000	1	0	2	150	9,000	1	0	2	150
	Type3	60	6,000	2	0	2	100	8,400	2	0	2	140	8,533	2	0	2	142	9,067	2	0	2	151	9,133	2	0	2	152
LDS-SAL/LFC-60	Type4	60	5,933	2	0	2	99	8,267	2	0	2	138	8,400	2	0	2	140	8,933	2	0	2	149	8,933	2	0	2	149
	Type5	60	6,133	3	0	3	102	8,533	3	0	3	142	8,667	3	0	3	144	9,200	3	0	3	153	9,267	3	0	3	154
	Type2	75	6,333	2	0	2	84	9,750	2	0	2	130	9,833	2	0	2	131	11,083	2	0	2	148	10,250	2	0	2	137
	Type3	75	6,250	2	0	2	83	9,583	2	0	2	128	9,750	2	0	2	130	11,167	2	0	2	149	10,333	2	0	2	138
	Type4	75	6,583	2	0	2	88	9,417	2	0	2	126	9,583	2	0	2	128	10,917	2	0	2	146	10,083	2	0	2	134
LDS-SAL/LFC-75	Type5	75	7,167	3	0	3	96	9,750	3	0	3	130	9,917	3	0	3	132	11,083	3	0	3	148	10,250	3	0	3	137
	Type2	80	8,000	2	0	2	100	10,133	2	0	2	127	10,311	2	0	2	129	11,733	2	0	2	147	10,578	2	0	2	132
	Type3	80	7,911	3	0	3	99	10,044	3	0	3	126	10,133	3	0	3	127	11,822	3	0	3	148	10,667	3	0	3	133
	Type4	80	7,733	3	0	3	97	9,867	3	0	3	123	9,956	3	0	3	124	11,644	3	0	3	146	10,489	3	0	3	131
	Type5	80	8,000	4	0	2	100	10,133	4	0	2	127	10,311	4	0	2	129	11,733	4	0	2	147	10,578	4	0	2	132
LDS-SAL/LFC-85	Type2	85	9,917	2	0	2	117	12,089	2	0	2	142	12,183	2	0	2	143	12,750	2	0	2	150	13,317	2	0	2	157
	Type3	85	10,011	3	0	3	118	12,183	3	0	3	143	12,278	3	0	3	144	12,844	3	0	3	151	13,411	3	0	3	158
	Type4	85	9,633	3	0	3	113	11,711	3	0	3	138	11,900	3	0	3	140	12,372	3	0	3	146	13,033	3	0	3	153
	Type5	85	10,106	4	0	2	119	12,372	4	0	2	146	12,561	4	0	2	148	13,033	4	0	2	153	13,694	4	0	2	161
	Type2	95	13,194	2	0	2	139	14,250	2	0	2	150	14,461	2	0	2	152	14,989	2	0	2	158	15,517	2	0	2	163
LDS-SAL/LFC-95	Type3	95	13,300	3	0	3	140	14,356	3	0	3	151	14,567	3	0	3	153	14,989	3	0	3	158	15,622	3	0	3	164
	Type4	95	12,878	3	0	3	136	13,933	3	0	3	147	14,039	3	0	3	148	14,567	3	0	3	153	15,200	3	0	3	160
	Type5	95	13,406	4	0	2	141	14,567	4	0	2	153	14,778	4	0	2	156	15,306	4	0	2	161	15,833	4	0	2	167
	Type2	110	13,933	2	0	2	127	16,500	2	0	2	150	16,011	2	0	2	146	16,133	2	0	2	147	16,133	2	0	2	147
	Type3	110	14,056	3	0	3	128	16,744	3	0	3	152	16,133	3	0	3	147	16,256	3	0	3	148	16,256	3	0	3	148
LDS-SAL/LFC-110	Type4	110	13,567	3	0	3	123	16,133	3	0	3	147	15,889	3	0	3	144	15,889	3	0	3	144	15,889	3	0	3	144
	Type5	110	14,300	4	0	2	130	16,256	4	0	2	148	16,011	4	0	2	146	16,133	4	0	2	147	16,133	4	0	2	147
	Type2	125	15,417	2	0	2	123	18,472	2	0	2	148	18,194	2	0	2	146	17,917	2	0	2	143	17,917	2	0	2	143
	Type3	125	15,556	3	0	3	124	18,611	3	0	3	149	18,333	3	0	3	147	18,056	3	0	3	144	18,056	3	0	3	144
	Type4	125	15,000	3	0	3	120	17,917	3	0	3	143	18,056	3	0	3	144	17,778	3	0	3	142	17,778	3	0	3	142
LDS-SAL/LFC-125	Type5	125	15,556	4	0	2	124	18,194	4	0	2	146	18,194	4	0	2	146	18,056	4	0	2	144	18,056	4	0	2	144
	Type2	160	19,200	2	0	2	120	22,933	2	0	2	143	23,289	2	0	2	146	24,356	2	0	2	152	24,356	2	0	2	152
	Type3	160	19,378	3	0	3	121	23,111	3	0	3	144	23,467	3	0	3	147	24,533	3	0	3	153	24,533	3	0	3	153
	Type4	160	19,022	3	0	3	119	22,756	3	0	3	142	22,933	3	0	3	143	24,178	3	0	3	151	24,178	3	0	3	151
	Type5	160	19,378	5	0	3	121	23,289	5	0	3	146	23,289	5	0	3	146	24,356	5	0	3	152	24,356	5	0	3	152
LDS-SAL/LFC-200	Type2	200	21,333	3	0	3	107	27,333	3	0	3	137	27,556	3	0	3	138	27,111	3	0	3	136	27,778	3	0	3	139
	Type3	200	21,556	3	0	3	108	27,556	3	0	3	138	27,778	3	0	3	139	27,333	3	0	3	137	28,444	3	0	3	142
	Type4	200	21,111	3	0	4	106	26,000	3	0	4	130	27,333	3	0	4	137	26,889	3	0	4	134	27,556	3	0	4	138
	Type5	200	21,333	5	0	5	107	26,889	5	0	5	134	27,778	5	0	5	139	27,333	5	0	5	137	27,778	5	0	5	139
	Type2	220	23,467	3	0	3	107	30,067	3	0	3	137	30,311	3	0	3	138	30,311	3	0	3	138	30,311	3	0	3	138
LDS-SAL/LFC-220	Type3	220	23,711	3	0	3	108	30,311	3	0	3	138	30,556	3	0	3	139	30,556	3	0	3	139	30,556	3	0	3	139
	Type4	220	23,222	3	0	4	106	28,600	3	0	4	130	30,067	3	0	4	137	30,067	3	0	4	137	30,067	3	0	4	137
	Type5	220	23,467	5	0	5	107	29,578	5	0	5	134	30,556	5	0	5	139	30,556	5	0	5	139	30,556	5	0	5	139

Performance Data
Electrical Load Data

Fixture Model	Drive Current (mA)	System Watts (W)	AC Current Load (A)				
			120V	208V	240V	277V	480V
LDS-SAL-30	550	30	0.28	0.16	0.14	0.12	0.07
LDS-SAL-45	875	45	0.42	0.24	0.21	0.18	0.10
LDS-SAL-60	1100	60	0.56	0.32	0.28	0.24	0.14
LDS-SAL-75	1475	75	0.70	0.40	0.36	0.31	0.18
LDS-SAL-80	1480	80	0.74	0.43	0.37	0.32	0.19
LDS-SAL-85	695	85	0.79	0.45	0.40	0.35	0.20
LDS-SAL-95	840	95	0.89	0.51	0.44	0.39	0.23
LDS-SAL-110	975	110	1.02	0.59	0.51	0.44	0.25
LDS-SAL-125	1150	125	1.16	0.67	0.58	0.50	0.29
LDS-SAL-160	1450	160	1.48	0.85	0.74	0.64	0.37
LDS-SAL-200	1642	200	1.86	1.06	0.92	0.82	0.48
LDS-SAL-220	1925	220	2.05	1.17	1.00	0.90	0.53

Lumen Maintenance

Data in the table below references projected performance in a 25°C ambient and is based on 10,000 hours of LED testing. Performance data has been tested per IESNA LM-80-08 and projected per IESNA TM-21-11.

Use the lumen maintenance factor that corresponds to the desired number of operating hours below to calculate LLF.

Fixture Model	Lumen Maintenance Factors @ 25°C, by hours:				
	0	25,000	50,000	70,000	100,000
LDS-SAL-30	1.0	0.99	0.96	0.92	0.85
LDS-SAL-45	1.0	0.99	0.96	0.92	0.85
LDS-SAL-60	1.0	0.99	0.96	0.92	0.85
LDS-SAL-75	1.0	0.99	0.96	0.92	0.85
LDS-SAL-80	1.0	0.99	0.96	0.92	0.85
LDS-SAL-85	1.0	0.99	0.96	0.92	0.85
LDS-SAL-95	1.0	0.99	0.96	0.92	0.85
LDS-SAL-110	1.0	0.99	0.96	0.92	0.85
LDS-SAL-125	1.0	0.99	0.96	0.92	0.85
LDS-SAL-160	1.0	0.99	0.96	0.92	0.85
LDS-SAL-200	1.0	0.99	0.96	0.92	0.85
LDS-SAL-220	1.0	0.99	0.96	0.92	0.85