

PROJECT NAME: _____

CATALOG #: _____

NOTES: _____

DATE: _____



BLS-SLSQ SPORTS AREA LIGHT - Square

The BLS-SLSQ square court light is different from the round court light in appearance, the BLS-SLSQ is more suitable for stadium lighting with higher lighting requirements. Precision designed optics with high output and high efficiency provide effective illumination covering the entire stadium in all directions, ensuring uniformity of illumination and providing excellent and comfortable illumination. At the same time, it supports two completely different installation methods of power random and remote control, which maximizes the practicality of luminaires with budget-friendly costs.

SPECIFICATIONS FEATURES

Construction:

- Strong and durable sealed die-casting profile for outdoor applications.
- Low profile, compact design minimizes wind load requirements.
- Housing is completely sealed against moisture and environmental contaminants (IP65).

Optics:

- Available in NEMA 2Hx2V, 3Hx3V, 4Hx4V, 5Hx5V, 6Hx6V distributions.
- Light engines are available in standard 4000 K, 5000K and 5700 K (70/80/90 CRI) configurations.
- Scalable Lumen Packages from 72,000 to 180,000 Lumens.
- Optics is precisely designed to shape the distribution, maximizing efficiency and application spacing.

Electrical:

- Ultra-wide input voltage: 200-480VAC or 120-277V.
- Standard with 0-10V dimming driver(s)
- Built in surge suppression with max 40KV.
- THD: $\leq 15\%$
- Power Factor: $\geq 90\%$

Ambient Temperature:

- Ambient operating temperature -40°C to 50°C (-40°F to 122°F)

Lifespan:

- Estimated 100,000-hour LED lifespan based on IES LM-80 results and TM-21 calculations

Certification:

- UL wet location listed

*NOTE- Actual performance may differ as a result of end-user environment and application.
All values are design or typical values, measured under laboratory conditions at $25^{\circ}\text{C}(\pm 5^{\circ}\text{C})$
specifications subject to change without notice.*



REMOTE DRIVER OPTION

The BLS-SLSQ supports remote installation of the drive power - simple installation, access and maintenance of the equipment can be met by placing the drive power of the fixture at the bottom of the pole by using a fixture and extension power cord (sold separately).

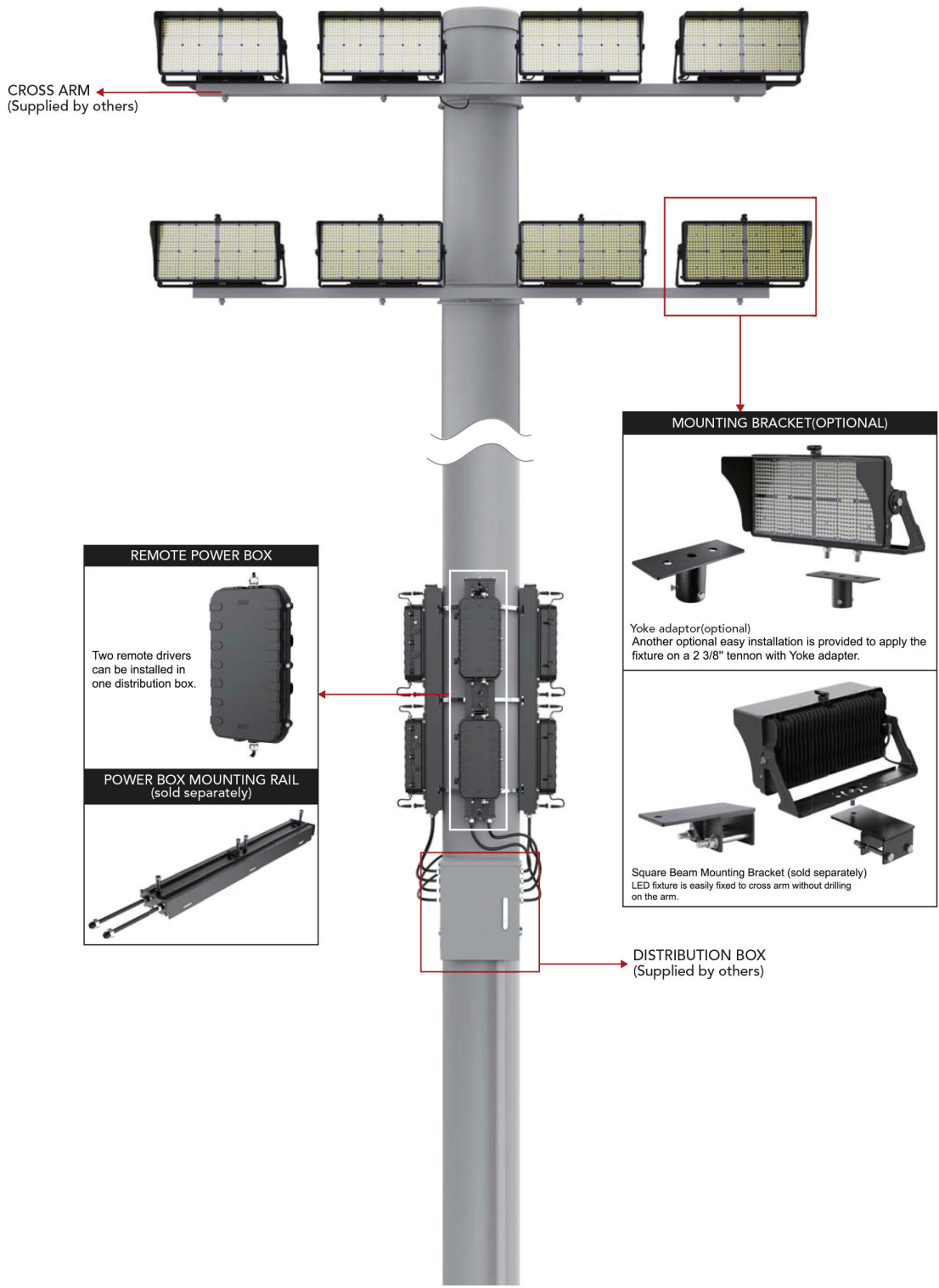

POWER BOX ATTACHED OPTION

The fixture with separate power can be installed on the top of the light pole as a whole unit, which is simple and fast way, without additional labor costs to install the driver. It is also beneficial to reduce the power consumption of fixtures caused by remote wiring, save energy and improve efficiency.

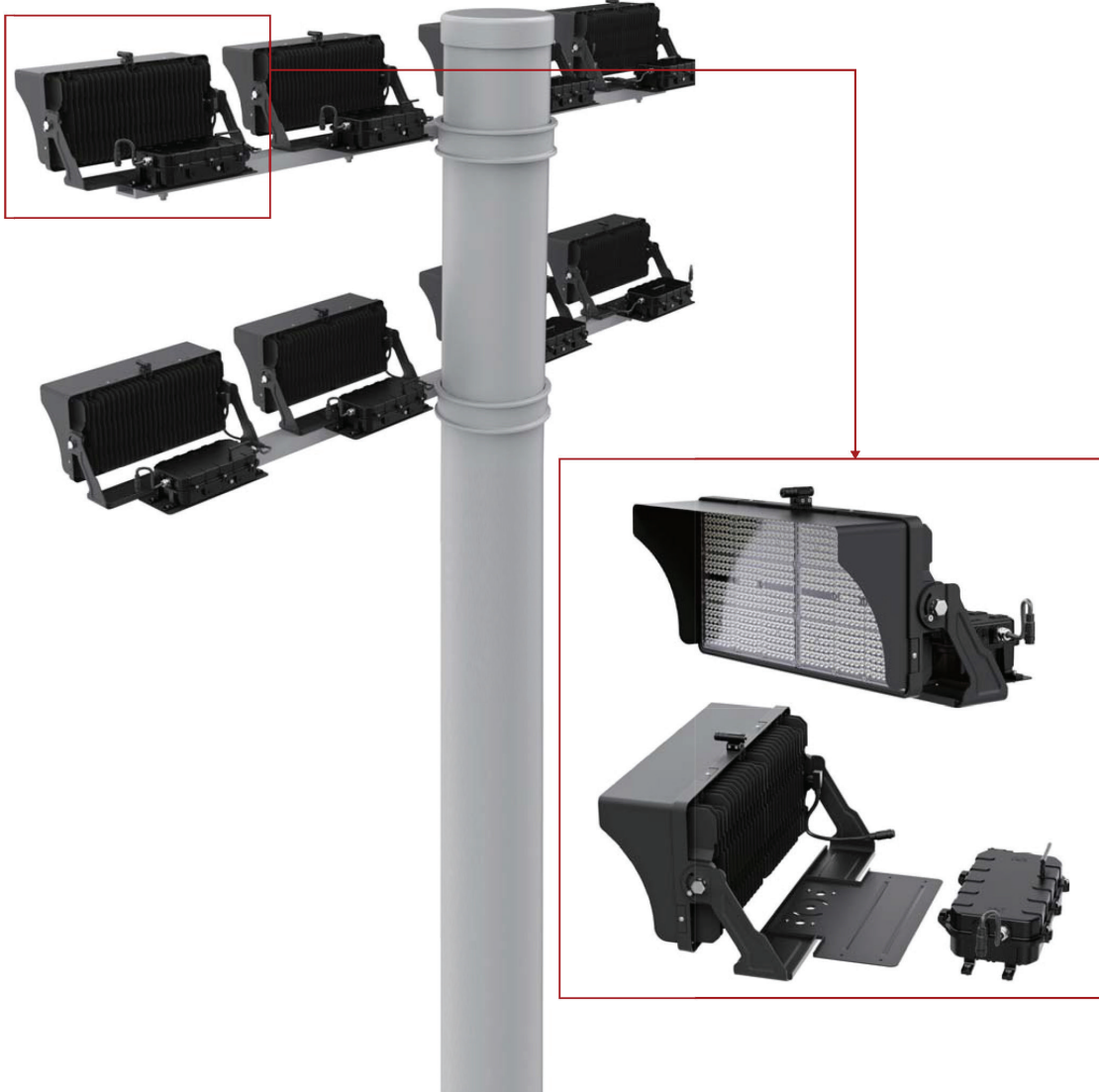

ORDERING GUIDE

SAMPLE: BLS-SLSQ-500-27V-40-B-B22-TR



MODEL	WATTAGE	VOLTAGE	CCT	FINISH	NEMA	MOUNTING	INTERNAL CODE
BLS-SLSQ	500 - 500W	27V - 120-277V	40 - 4000K	B - Black	B22 - 2Hx2V	TR - Trunion	Blank
	600 - 600W	48V - 200-480V	50 - 5000K		B33 - 3Hx3V		Alphanumeric
	850 - 850W		57 - 5700K		B44 - 4Hx4V		
	1200 - 1200W				B55 - 5Hx5V ¹		
					B66 - 6Hx6V ¹		

Note:

1. Only 500W optional for 120-277V input voltage.

PERFORMANCE DATA

SIZE	SYSTEM WATTS	VOLTAGE	EPA	CRI	LUMENS (4000K)	LPW (4000K)	LUMENS (5000K)	LPW (5000K)	LUMENS (5700K)	LPW (5700K)
Small Size	500W	120-277V 200-480V	1.8202	70	75000lm	150 lm/W	75000lm	150 lm/W	72000lm	144 lm/W
Small Size	600W	200-480V	1.8202	70	92000lm	153 lm/W	92000lm	153 lm/W	90000lm	150 lm/W
Large Size	850W	200-480V	3.3821	70	125000lm	147 lm/W	125000lm	147 lm/W	122000lm	144 lm/W
Large Size	1200W	200-480V	3.3821	70	180000lm	150 lm/W	180000lm	150 lm/W	170000lm	142 lm/W

ELECTRICAL DATA

Number Of Drivers	Driver Current (mA)	Nominal Power (W)	INPUT VOLTAGE (V)	CURRENT (Amps)
1	1600	500	120	4.17
		500	208	2.40
		500	240	2.08
		500	277	1.81
		500	347	1.44
		500	480	1.04
1	1800	600	208	2.88
		600	240	2.50
		600	277	2.17
		600	347	1.73
		600	480	1.25
1	2700	850	208	4.09
		850	240	3.54
		850	277	3.07
		850	347	2.45
		850	480	1.77
1	3600	1200	208	5.77
		1200	240	5.00
		1200	277	4.33
		1200	347	3.46
		1200	480	2.50

DIMENSIONS

With Power Box Attached

Small Size: 500W & 600W

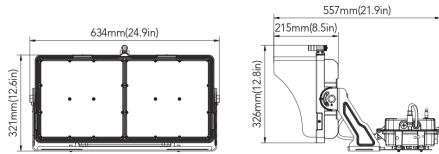

Large Size: 850W & 1200W

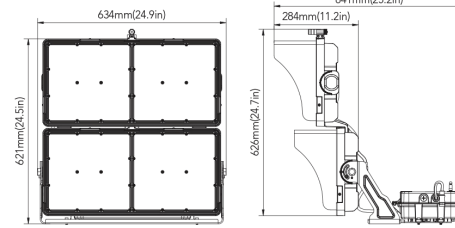

With Remote Power Box

Small Size: 500W & 600W

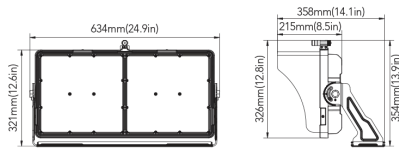

Large Size: 850W & 1200W

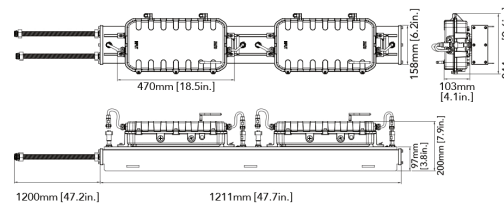
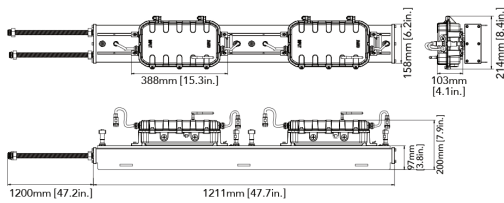
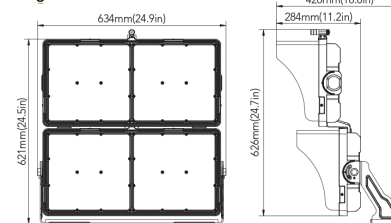

PHOTOMETRICS

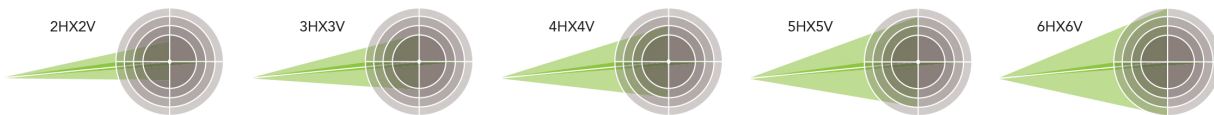

ACCESSORIES

 <p>Black Top Visor (default)</p>	 <p>Aiming Sight (default)</p>	 <p>Yoke Adaptor (option)</p>	 <p>Square Beam Mounting Bracket (sold separately)</p>
 <p>Extension Cord up to 164' (50m)</p>	 <p>Power Box Mounting Rail (sold separately)</p>		