

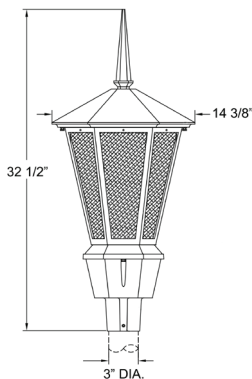

Shown with:  
H6730RLED Style  
Black Finish  
CA - Clear Acrylic



H6730RLED Style  
H: 32 1/2"  
W: 14 3/8"  
EPA: 1.24  
Fitter: 3" Diameter

## Technical Specifications

**HOUSING:** Slip fits over 2 7/8" and 3" OD tenons on most decorative poles. Cast aluminum housing uses A356 aluminum comprises 92.05% Aluminum, 7% Silicon, 0.35% Magnesium, 0.20% Iron, 0.20% Copper, 0.10% Manganese, and 0.10% Zinc. It is lightweight and highly corrosion-resistant, like stainless steel. Heat treated to improve strength—low impurities cause high strength and ductility.

**FINISH:** Cast aluminum fitter housing with textured or 60% gloss polyester powder coat finishes for maximum durability. The base aluminum material is prepared using an environmentally friendly non-chrome 2-step surface cleaning and passivation process. The process results in a more durable conversion layer than traditional chromate conversion coatings and allows maximum powder coating adhesion to the aluminum fitter.

### POWERED BY THE LUMECON L-RETRO-T LIGHT ENGINE

**INPUT VOLTAGE:** 120-277V or 347-480V

**EFFECTIVE PROJECTED AREA (EPA):** 1.24 ft<sup>2</sup>

**CUSTOM OPTICS:** Lumecon meticulously engineered premium acrylic optical lenses to maximize the distribution and uniformity of light while minimizing cost. Our arrays distribute light at least 21% further and with 29% more uniformity than leading competitors. Lumecon custom lenses create a uniform, well-lit environment that mitigates illuminance "hot spots" and uses less wattage than typical LED area lights.



L-RETRO-T  
Light Engine

**LUMECON ETD™ SYSTEM:** The enhanced thermal dissipation system engines are thermally bonded to provide maximum thermal dissipation to the fixture's exterior to ensure long life. To protect the light engine panel from moisture and corrosion, the LED light engine panel is uniformly coated with a UV-stabilized acrylic polymer resin that meets MIL and ASTM dielectric standards, UL, and IPC standards for flammability, moisture resistance, and thermal shock.

**COLOR TEMPERATURE:** 2700K, 3000K, 4000K, and 5000K.

**LED LIFETIME:** All LEDs are rated for a minimum of 100,000 hours of continuous operation at ambient temperatures from -40°F/-40°C to 115°F/46°C.

**COLOR RENDERING INDEX (CRI):** Minimum of 80 or higher. CRI 90+ is available upon request. CRI 90+ is not available in 2200K.

**DIMMING:** 0-10V standard dimming capability.

**SURGE PROTECTION:** Thermally protected 20kA/ 40kV varistor type surge suppressor is included and meets ANSI C136.2- 2015: Extreme Level. It also meets IEC61643-11 Class II / EN61643-11 Type 2 and US Dept of Energy MSSLC Model Spec for surge protection. The device is wired in series with the luminaire input power to interrupt power to the luminaire when consumed, protecting the LED power supply and circuit boards from additional electrical surges.

**MANUFACTURING ORIGIN:** US Manufactured and Assembled.

**BUY AMERICAN ACT:** The product is assembled in the USA and meets the Buy America(n) government procurement requirements under FAR, DFARS, and DOT regulations.

**BABA COMPLIANT:** Meets Build America, Buy America Act Included in the Infrastructure Investment and Jobs Act, Public Law Number 117-58, Title IX, Subtitle A, Part 1 – Buy America Sourcing Requirements, Sections 70911-70917 stating Manufactured in the U.S. The cost of components mined, produced, or manufactured in the U.S. is greater than 55 percent of the total cost of all manufactured product components.

**DESIGNLIGHTS CONSORTIUM® (DLC) QUALIFIED PRODUCT:** Unless noted, not all versions of this product may be DLC® qualified. For a complete list of Lumecon DLC® Qualified Products visit: [www.designlights.org](http://www.designlights.org).

**CERTIFICATION:** Manufactured with ETL-compliant components.

**WARRANTY:** 10 Year L70 performance-based warranty. For full warranty terms, please visit our website: [www.lumecon.com](http://www.lumecon.com).



L-RETRO-T  
LIGHT ENGINE

Intertek

Email: [sales@lumecon.com](mailto:sales@lumecon.com) Website: [www.lumecon.com](http://www.lumecon.com) Phone: 248-477-5009

Copyright © 2026 Lumecon LLC. All Rights Reserved.

Note: Specifications and photometric data are subject to change at any time without notice.

Please see [www.lumecon.com](http://www.lumecon.com) for current specifications and documentation.

Sheet/LM-ADM\_02132026

**PERFORMANCE DATA**

| Model  | Distribution Type | Watts | 2200K  |          | 2700K  |          | 3000K  |          | 4000K  |          | 5000K  |          |
|--------|-------------------|-------|--------|----------|--------|----------|--------|----------|--------|----------|--------|----------|
|        |                   |       | Lumens | Efficacy | Lumens | Efficacy | Lumens | Efficacy | Lumens | Efficacy | Lumens | Efficacy |
| LM-ADM | Type 2            | 25W   | 2,500  | 100      | 3,100  | 124      | 3,125  | 125      | 3,500  | 140      | 3,500  | 140      |
|        | Type 3            | 25W   | 2,575  | 103      | 3,175  | 127      | 3,225  | 129      | 3,600  | 144      | 3,600  | 144      |
|        | Type 4            | 25W   | 2,450  | 98       | 3,050  | 122      | 3,075  | 123      | 3,425  | 137      | 3,450  | 137      |
|        | Type 5            | 25W   | 2,475  | 99       | 3,050  | 122      | 3,075  | 123      | 3,450  | 138      | 3,450  | 138      |
| LM-ADM | Type 2            | 40W   | 4,120  | 103      | 5,087  | 127      | 5,150  | 129      | 5,712  | 143      | 5,712  | 143      |
|        | Type 3            | 40W   | 4,142  | 104      | 5,114  | 128      | 5,177  | 129      | 5,743  | 144      | 5,743  | 144      |
|        | Type 4            | 40W   | 4,109  | 103      | 5,073  | 127      | 5,135  | 128      | 5,696  | 142      | 5,696  | 142      |
|        | Type 5            | 40W   | 4,110  | 103      | 5,074  | 17       | 5,137  | 128      | 5,697  | 142      | 5,697  | 142      |
| LM-ADM | Type 2            | 60W   | 6,084  | 101      | 7,511  | 125      | 7,604  | 127      | 8,448  | 141      | 8,448  | 141      |
|        | Type 3            | 60W   | 6,117  | 102      | 7,552  | 126      | 7,646  | 127      | 8,494  | 142      | 8,494  | 142      |
|        | Type 4            | 60W   | 6,066  | 101      | 7,489  | 125      | 7,583  | 126      | 8,424  | 140      | 8,424  | 140      |
|        | Type 5            | 60W   | 6,068  | 101      | 7,491  | 125      | 7,585  | 126      | 8,426  | 140      | 8,426  | 140      |

**ORDERING INFORMATION**

Lumecon Midtown Post-Top Series

Example Part Number: LM-ADM-H6730RLED-40-1-40-T2-WA-BLK-PC-BL

| REQUIRED |           |               |                 |            |               |                        |                          | OPTIONAL        |                         |  |
|----------|-----------|---------------|-----------------|------------|---------------|------------------------|--------------------------|-----------------|-------------------------|--|
| MODEL    | STYLE     | WATTAGE       | VOLTAGE         | CCT        | DISTRIBUTION  | LENS                   | FINISH                   | PHOTOCELL       | HOUSE SIDE SHIELD       | DIMMING CONTROLS                         |
| LM-ADM   | H6730RLED | 25 - 25 Watts | 1 - 120v - 277v | 22 - 2200K | T2 - Type II  | CA - Clear Acrylic     | See Samples on next page | PC - Button Eye | BL - Back Light Louvers | FAWS - Field Adjustable Wattage Selector |
|          | H6710RLED | 40 - 40 Watts | 2 - 347v - 480v | 27 - 2700K | T3 - Type III | PA - Prismatic Acrylic |                          |                 |                         |  |
|          |           | 60 - 60 Watts |                 | 30 - 3000K | T4 - Type IV  | WA - White Acrylic     |                          |                 |                         |  |
|          |           |               |                 | 40 - 4000K | T5 - Type V   |                        |                          |                 |                         |  |
|          |           |               |                 | 50 - 5000K |               |                        |                          |                 |                         |  |

**Product Style Samples**



**H6730RLED**  
H: 32 1/2"  
W: 14 3/8"  
EPA: 1.24  
Fitter: 3" Dia.

To view specific details,  
[download here](#)

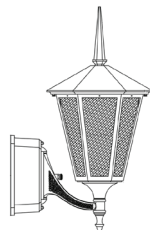

**H6710RLED**  
H: 30 1/4"  
W: 14 1/2"  
Proj: 18 3/8"  
T/O: 23 1/8"

To view specific details,  
[download here](#)

**Available Finishes**

Standard



Premium

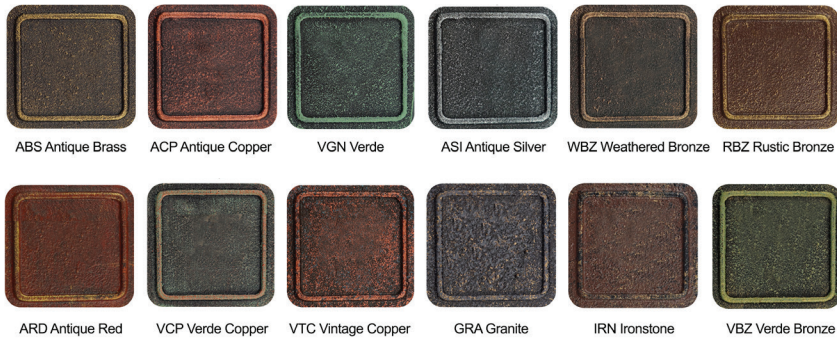

## OPTIONAL BASE AND POLE ORDERING INFORMATION

| DECORATIVE BASE OPTIONS | POLE OPTIONS            | MOUNTING HEIGHTS |          |          | FINISH                            |
|-------------------------|-------------------------|------------------|----------|----------|-----------------------------------|
| H-Arlen-17              | Round Straight Aluminum | 08 - 8'          | 14 - 14' | 20 - 20' | 01 - Satin Aluminum (RTA and RSA) |
| H-York-17               | Round Tapered Aluminum  | 10 - 10'         | 16 - 16' | 25 - 25' | 02 - Satin Aluminum (SSA)         |
| H-Homewood              | Round Fluted Aluminum   | 12 - 12'         | 18 - 18' | 30 - 30' | BA - Black Powder Coat            |
| H-Morgan                |                         |                  |          |          | BH - White Powder Coat            |
|                         |                         |                  |          |          | BM - Dark Bronze Powder Coat      |
|                         |                         |                  |          |          | BV - Dark Green Powder Coat       |
|                         |                         |                  |          |          | GC - Gray Powder Coat             |
|                         |                         |                  |          |          | .. - Specify Finish               |

For additional options, download [Decorative Base Catalog here](#)

For additional options, download [Pole Guide here](#)



### NEED MORE CHOICES?

For additional Globe options, download [Globe Catalog here](#)

## Decorative Bases Ordering Information

Over 58 Base options available. The most popular listed below. To view all options, download [Base Guide here](#)

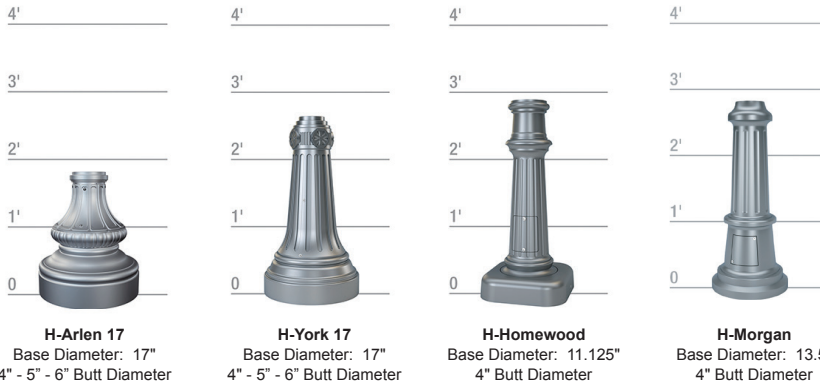

**For detailed design, quote, and specific cut sheet information, contact Lumecon at [Sales@Lumecon.com](mailto:Sales@Lumecon.com)**

## Accessories Ordering Information

For additional information on Accessories and Options, download [Pole Guide here](#)

### Cast Banner Arms

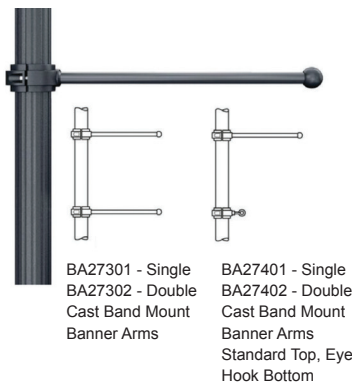

### Banner Saver Arms

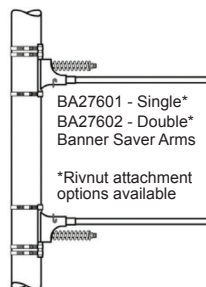

### GFI Receptacle Outlet Box

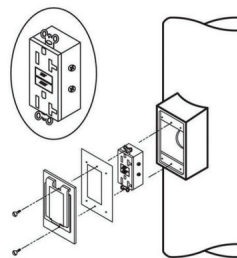

### Additional Accessories

- Flower Pot Holders
- FHWA Accepted Break Away Systems
- Additional Hand Holes
- Camera Mounts
- Decorative Arms
- Slip Fitter Tenons
- Vibratoin Dampeners
- Sign Brackets