

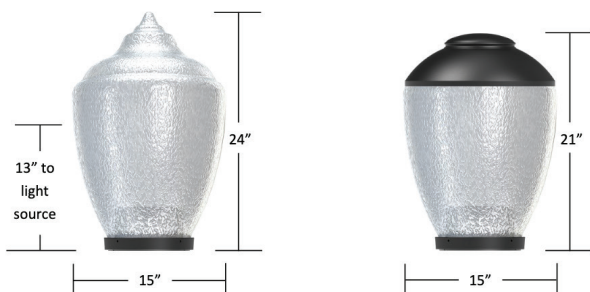

Shown with:  
BH2 Fitter  
CA - Clear Acrylic Globe

Requires nominal 3" diameter x 2 7/8" tall tenon



Shown with:  
SR2 Solid Roof  
CA - White Acrylic Globe

## Technical Specifications

### GLOBE MATERIALS

**Acrylic** - Impact modified and UV resistant with continuous operating temperature up to 80°C. Maximum transmittance of 92% (clear). Acrylic streetlamps are available in clear or white. LD Acrylic - Impact modified and UV resistant with continuous operating temperature up to 80°C and transmittance of 90% to 94% (application dependent).

**Polycarbonate** - UV stabilized with a continuous operating temperature of 100°C to 125°C, high impact resistance down to -40the °C, and transmittance of 88% (application dependent). Polycarbonate streetlamps are available in clear.

**FITTER:** Slip fits over 2 7/8" and 3" OD tenons on most decorative poles. Requires nominal 3" diameter x 2 7/8" tall tenon. Uses A356 aluminum comprises 92.05% Aluminum, 7% Silicon, 0.35% Magnesium, 0.20% Iron, 0.20% Copper, 0.10% Manganese, and 0.10% Zinc. It is lightweight and highly corrosion-resistant, like stainless steel. Heat treated to improve strength—low impurities cause high strength and ductility.

**FINISH:** Cast aluminum fitter housing with textured or 60% gloss polyester powder coat finishes for maximum durability. The base aluminum material is prepared using an environmentally friendly non-chrome 2-step surface cleaning and passivation process. The process results in a more durable conversion layer than traditional chromate conversion coatings and allows maximum powder coating adhesion to the aluminum fitter.

### POWERED BY THE LUMECON L-RETRO-DG LIGHT ENGINE

**INPUT VOLTAGE:** 120-277V or 347-480V

**EFFECTIVE PROJECTED AREA (EPA):** 0.65 ft<sup>2</sup>

**LIGHT ENGINE:** Each LED light engine consists of a circuit board of 80 Midpower LEDs. The LED board is mounted to a 0.125 aluminum disk and heat sink for maximum heat dissipation from the LEDs.

**LUMECON ETD™ SYSTEM:** The enhanced thermal dissipation system engines are thermally bonded to provide maximum thermal dissipation to the fixture's exterior to ensure long life. To protect the light engine panel from moisture and corrosion, the LED light engine panel is uniformly coated with a UV-stabilized acrylic polymer resin that meets MIL and ASTM dielectric standards, UL, and IPC standards for flammability, moisture resistance, and thermal shock.



**COLOR TEMPERATURE:** 2200K, 2700K, 3000K, 4000K, 5000K.

**LED LIFETIME:** All LEDs are rated for a minimum of 100,000 hours of continuous operation at ambient temperatures from -40°F/-40°C to 115°F/46°C.

**COLOR RENDERING INDEX (CRI):** Minimum of 80 or higher.

**DIMMING:** 0-10V standard dimming capability.

**SURGE PROTECTION:** Thermally protected 20kA/ 40kV varistor type surge suppressor is included and meets ANSI C136.2- 2015: Extreme Level. It also meets IEC61643-11 Class II / EN61643-11 Type 2 and US Dept of Energy MSSLC Model Spec for surge protection. The device is wired in series with the luminaire input power to interrupt power to the luminaire when consumed, protecting the LED power supply and circuit boards from additional electrical surges.

**MANUFACTURING ORIGIN:** US Manufactured and Assembled.

**BUY AMERICAN ACT:** The product is assembled in the USA and meets the Buy America(n) government procurement requirements under FAR, DFARS, and DOT regulations.

**BABA COMPLIANT:** Meets Build America, Buy America Act Included in the Infrastructure Investment and Jobs Act, Public Law Number 117-58, Title IX, Subtitle A, Part I – Buy America Sourcing Requirements, Sections 70911-70917 stating Manufactured in the U.S. The cost of components mined, produced, or manufactured in the U.S. is greater than 55 percent of the total cost of all manufactured product components.

**WARRANTY:** 10 Year L70 performance-based warranty. For full warranty terms, please visit our website: [www.lumecon.com](http://www.lumecon.com).

**CERTIFICATION:** Built with ETL/UL-certified components.

**DESIGNLIGHTS CONSORTIUM® (DLC) QUALIFIED PRODUCT:** Unless noted, not all versions of this product may be DLC® qualified. For a complete list of Lumecon DLC® Qualified Products visit: [www.designlights.org](http://www.designlights.org).



Email: [sales@lumecon.com](mailto:sales@lumecon.com) Website: [www.lumecon.com](http://www.lumecon.com) Phone: 248-477-5009

Copyright © 2026 Lumecon LLC. All Rights Reserved.

Note: Specifications and photometric data are subject to change at any time without notice. Please see [www.lumecon.com](http://www.lumecon.com) for current specifications and documentation.

Sheet/LM-GRL\_02132026

**PERFORMANCE DATA**

DISTRIBUTION	WATTAGE	2200K		2700K		3000K		4000K		5000K	
		LUMENS	EFFICACY	LUMENS	EFFICACY	LUMENS	EFFICACY	LUMENS	EFFICACY	LUMENS	EFFICACY
Type 5	35	3500	100	4480	128	4480	128	4585	131	4550	130
Type 5	45	4365	97	5580	124	5580	124	5895	131	5670	126
Type 5	55	5170	94	6655	121	6655	121	6765	123	6655	121

**ORDERING INFORMATION**

Lumecon Midtown Post-Top Series

Example Part Number: LM-GRL-35-1-CA-BH2-BK-K100292-SR2-FN1-32-00123-PC-7P

REQUIRED							OPTIONAL						
MODEL	WATTAGE	VOLTAGE	CCT	GLOBE	FITTER <sup>1</sup>	FINISH	BAND AND LEGS	SOLID ROOF	FINIAL	HOUSE SIDE SHIELD	PHOTOCELL	CONTROLS READY	DISTRIBUTION
LM-GRL	35 - 35 Watts	1 - 120v - 277v	22 - 2200K	CA - Clear Acrylic	X - None	BK - Black Gloss	K100292	SR2	FN1 <sup>3</sup>	32-00123 - House Side Shield	PC - Button Eye	7P - 7 Pin Receptacle	32-00114 - Type IV
	45 - 45 Watts	2 - 347v - 480v	27 - 2700K	WA - White Acrylic	BH0 <sup>2</sup>	BT - Black Textured			FN2				
	55 - 55 Watts		30 - 3000K	CP - Clear Polycarbonate	BH1	DB - Dark Bronze			FN3 <sup>3</sup>				
			40 - 4000K	LD - LD Visual Comfort	BH2	GN - Green			FN4				
			50 - 5000K		BH8	<b>Premium Finishes</b>							
				BH13 <sup>2</sup>	WH - White Gloss								
					BHU <sup>2</sup>	CF - Custom Finish							

**CAGES<sup>1</sup>**  
For additional options, download [Cages Guide here](#)

- Notes:  
 1. Cage and Fitter welded together requiring both to be selected  
 2. BH0, BH13, and BHU not compatible with Cages  
 3. FN1 and FN3 are Acrylic and only available in black

**Fitters**

**Band and Legs Sample**



For additional Information, download [Fitter Guide here](#)

For additional Information, download [Utility Fitter here](#)

**Solid Roof**

**Finials**

**House Side Shield**

**Distribution**

**Controls Ready**

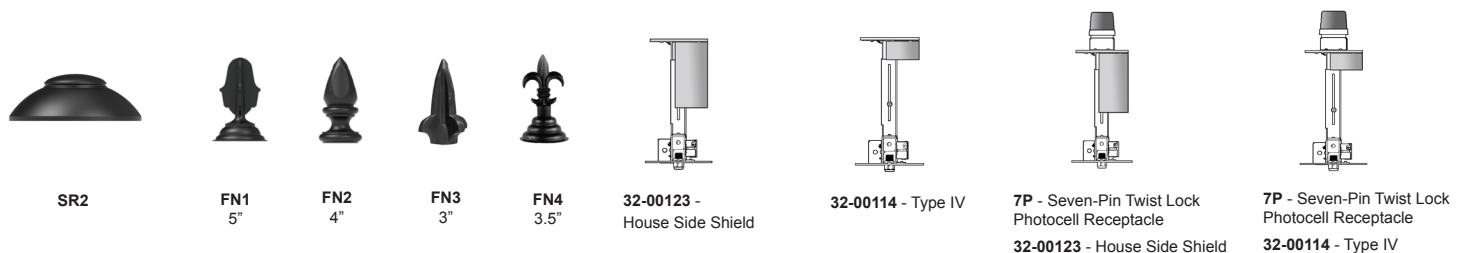

## OPTIONAL BASE AND POLE ORDERING INFORMATION

DECORATIVE BASE OPTIONS	POLE OPTIONS	MOUNTING HEIGHTS			FINISH
H-Arlen-17	Round Straight Aluminum	08 - 8'	14 - 14'	20 - 20'	01 - Satin Aluminum (RTA and RSA)
H-York-17	Round Tapered Aluminum	10 - 10'	16 - 16'	25 - 25'	02 - Satin Aluminum (SSA)
H-Homewood	Round Fluted Aluminum	12 - 12'	18 - 18'	30 - 30'	BA - Black Powder Coat
H-Morgan					BH - White Powder Coat
					BM - Dark Bronze Powder Coat
					BV - Dark Green Powder Coat
					GC - Gray Powder Coat
					.. - Specify Finish

For additional options, download [Decorative Base Catalog here](#)



For additional options, download [Pole Guide here](#)



**NEED MORE CHOICES?**  
For additional Globe options, download [Globe Catalog here](#)

### Decorative Bases Ordering Information

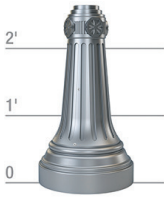
Over 58 Base options available. The most popular listed below. To view all options, download [Base Guide here](#)

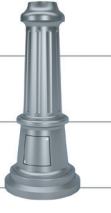
4' 3' 2' 1' 0	4' 3' 2' 1' 0	4' 3' 2' 1' 0	4' 3' 2' 1' 0
			
<b>H-Arlen 17</b> Base Diameter: 17" 4" - 5" - 6" Butt Diameter	<b>H-York 17</b> Base Diameter: 17" 4" - 5" - 6" Butt Diameter	<b>H-Homewood</b> Base Diameter: 11.125" 4" Butt Diameter	<b>H-Morgan</b> Base Diameter: 13.5" 4" Butt Diameter

**For detailed design, quote, and specific cut sheet information, contact Lumecon at [Sales@Lumecon.com](mailto:Sales@Lumecon.com)**

### Accessories Ordering Information

For additional information on Accessories and Options, download [Pole Guide here](#)

#### Cast Banner Arms

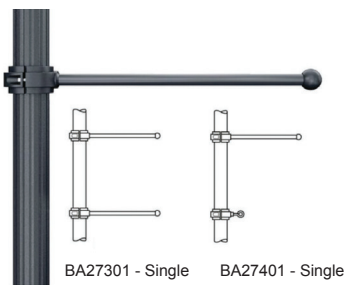

BA27301 - Single Cast Band Mount Banner Arms	BA27401 - Single Cast Band Mount Banner Arms Standard Top, Eye Hook Bottom
BA27302 - Double Cast Band Mount Banner Arms	BA27402 - Double Cast Band Mount Banner Arms Standard Top, Eye Hook Bottom

#### Banner Saver Arms

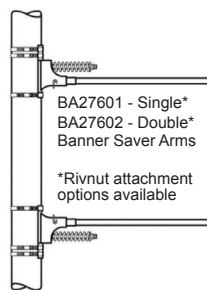

BA27601 - Single\*  
BA27602 - Double\*  
Banner Saver Arms

\*Rivnut attachment options available

#### GFI Receptacle Outlet Box

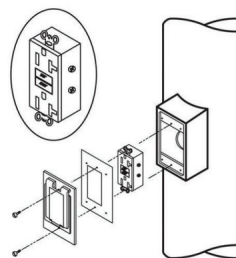

#### Additional Accessories

- Flower Pot Holders
- FHWA Accepted Break Away Systems
- Additional Hand Holes
- Camera Mounts
- Decorative Arms
- Slip Fitter Tenons
- Vibratoin Dampeners
- Sign Brackets