

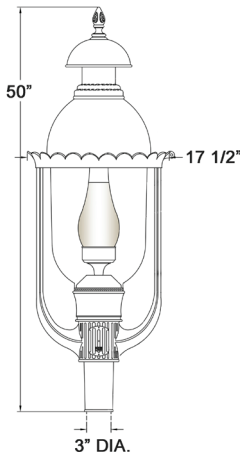

Shown with:
H1630RLED Style
Black Finish
CA - Clear Acrylic



H1630RLED Style
H: 50"
W: 17 1/2"
EPA: 2.60
Fitter: 3" Diameter

Technical Specifications

HOUSING: Slip fits over 2 7/8" and 3" OD tenons on most decorative poles. Cast aluminum housing uses A356 aluminum comprises 92.05% Aluminum, 7% Silicon, 0.35% Magnesium, 0.20% Iron, 0.20% Copper, 0.10% Manganese, and 0.10% Zinc. It is lightweight and highly corrosion-resistant, like stainless steel. Heat treated to improve strength—low impurities cause high strength and ductility.

FINISH: Cast aluminum fitter housing with textured or 60% gloss polyester powder coat finishes for maximum durability. The base aluminum material is prepared using an environmentally friendly non-chrome 2-step surface cleaning and passivation process. The process results in a more durable conversion layer than traditional chromate conversion coatings and allows maximum powder coating adhesion to the aluminum fitter.

POWERED BY THE LUMECON L-RETRO-T LIGHT ENGINE

INPUT VOLTAGE: 120-277V or 347-480V

EFFECTIVE PROJECTED AREA (EPA): 2.60 ft²

CUSTOM OPTICS: Lumecon meticulously engineered premium acrylic optical lenses to maximize the distribution and uniformity of light while minimizing cost. Our arrays distribute light at least 21% further and with 29% more uniformity than leading competitors. Lumecon custom lenses create a uniform, well-lit environment that mitigates illuminance "hot spots" and uses less wattage than typical LED area lights.



L-RETRO-T
Light Engine

LUMECON ETD™ SYSTEM: The enhanced thermal dissipation system engines are thermally bonded to provide maximum thermal dissipation to the fixture's exterior to ensure long life. To protect the light engine panel from moisture and corrosion, the LED light engine panel is uniformly coated with a UV-stabilized acrylic polymer resin that meets MIL and ASTM dielectric standards, UL, and IPC standards for flammability, moisture resistance, and thermal shock.

COLOR TEMPERATURE: 2700K, 3000K, 4000K, and 5000K.

LED LIFETIME: All LEDs are rated for a minimum of 100,000 hours of continuous operation at ambient temperatures from -40°F/-40°C to 115°F/46°C.

COLOR RENDERING INDEX (CRI): Minimum of 80 or higher. CRI 90+ is available upon request. CRI 90+ is not available in 2200K.

DIMMING: 0-10V standard dimming capability.

SURGE PROTECTION: Thermally protected 20kA/ 40kV varistor type surge suppressor is included and meets ANSI C136.2- 2015: Extreme Level. It also meets IEC61643-11 Class II / EN61643-11 Type 2 and US Dept of Energy MSSLC Model Spec for surge protection. The device is wired in series with the luminaire input power to interrupt power to the luminaire when consumed, protecting the LED power supply and circuit boards from additional electrical surges.

MANUFACTURING ORIGIN: US Manufactured and Assembled.

BUY AMERICAN ACT: The product is assembled in the USA and meets the Buy America(n) government procurement requirements under FAR, DFARS, and DOT regulations.

BABA COMPLIANT: Meets Build America, Buy America Act Included in the Infrastructure Investment and Jobs Act, Public Law Number 117-58, Title IX, Subtitle A, Part I – Buy America Sourcing Requirements, Sections 70911-70917 stating Manufactured in the U.S. The cost of components mined, produced, or manufactured in the U.S. is greater than 55 percent of the total cost of all manufactured product components.

DESIGNLIGHTS CONSORTIUM® (DLC) QUALIFIED PRODUCT: Unless noted, not all versions of this product may be DLC® qualified. For a complete list of Lumecon DLC® Qualified Products visit: www.designlights.org.

CERTIFICATION: Manufactured with ETL-compliant components.

WARRANTY: 10 Year L70 performance-based warranty. For full warranty terms, please visit our website: www.lumecon.com.



L-RETRO-T
LIGHT ENGINE

PERFORMANCE DATA

Model	Distribution Type	Watts	2200K		2700K		3000K		4000K		5000K	
			Lumens	Efficacy	Lumens	Efficacy	Lumens	Efficacy	Lumens	Efficacy	Lumens	Efficacy
LM-MCK	Type 2	25W	2,500	100	3,100	124	3,125	125	3,500	140	3,500	140
	Type 3	25W	2,575	103	3,175	127	3,225	129	3,600	144	3,600	144
	Type 4	25W	2,450	98	3,050	122	3,075	123	3,425	137	3,450	137
	Type 5	25W	2,475	99	3,050	122	3,075	123	3,450	138	3,450	138
LM-MCK	Type 2	40W	4,120	103	5,087	127	5,150	129	5,712	143	5,712	143
	Type 3	40W	4,142	104	5,114	128	5,177	129	5,743	144	5,743	144
	Type 4	40W	4,109	103	5,073	127	5,135	128	5,696	142	5,696	142
	Type 5	40W	4,110	103	5,074	127	5,137	128	5,697	142	5,697	142
LM-MCK	Type 2	60W	6,084	101	7,511	125	7,604	127	8,448	141	8,448	141
	Type 3	60W	6,117	102	7,552	126	7,646	127	8,494	142	8,494	142
	Type 4	60W	6,066	101	7,489	125	7,583	126	8,424	140	8,424	140
	Type 5	60W	6,068	101	7,491	125	7,585	126	8,426	140	8,426	140
LM-MCK	Type 2	80W	7,982	100	9,854	123	9,979	125	11,104	139	11,104	139
	Type 3	80W	8,026	100	9,909	124	10,035	125	11,166	140	11,166	140
	Type 4	80W	7,958	99	9,825	123	9,950	124	11,072	138	11,072	138
	Type 5	80W	7,961	100	9,828	123	9,953	124	11,075	138	11,075	138

ORDERING INFORMATION

Lumecon Midtown Post-Top Series

Example Part Number: LM-MCK-H1630RLED-45-1-40-T2-WA-BLK-PC-BL

REQUIRED								OPTIONAL		
MODEL	STYLE	WATTAGE	VOLTAGE	CCT	DISTRIBUTION	LENS	FINISH	PHOTOCELL	HOUSE SIDE SHIELD	DIMMING CONTROLS
LM-MCK	H1630RLED	25 - 25 Watts	1 - 120v - 277v	22 - 2200K	T2 - Type II	NL - No Lens*	See Samples on next page	PC - Button Eye	BL - Back Light Louvers	FAWS - Field Adjustable Wattage Selector
	H1630FRLED	40 - 40 Watts	2 - 347v - 480v	27 - 2700K	T3 - Type III	CA - Clear Acrylic				
		60 - 60 Watts		30 - 3000K	T4 - Type IV	PA - Prismatic Acrylic				
		80 - 80 Watts		40 - 4000K	T5 - Type V	WA - White Acrylic				
				50 - 5000K		*Dark Sky Compliant with 3000K, 2700K and 2200K CCT				

Product Style Samples

H1630RLED
 H: 50"
 W: 17 1/2"
 EPA: 2.60
 Fitter: 3" Dia.

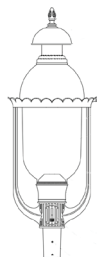
 To view specific details,
[download here](#)

H1630FRLED
 H: 50"
 W: 17 1/2"
 EPA: 2.60
 Fitter: 3" Dia.

 To view specific details,
[download here](#)

Available Finishes

Standard



Premium

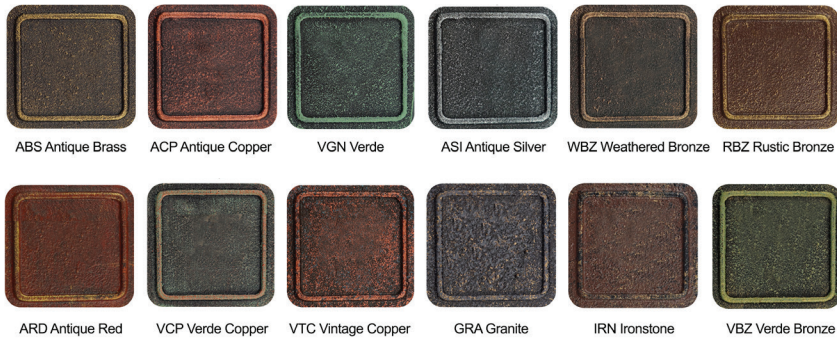

OPTIONAL BASE AND POLE ORDERING INFORMATION

DECORATIVE BASE OPTIONS	POLE OPTIONS	MOUNTING HEIGHTS	FINISH
H-Arlen-17	Round Straight Aluminum	08 - 8' 14 - 14' 20 - 20'	01 - Satin Aluminum (RTA and RSA)
H-York-17	Round Tapered Aluminum	10 - 10' 16 - 16' 25 - 25'	02 - Satin Aluminum (SSA)
H-Homewood	Round Fluted Aluminum	12 - 12' 18 - 18' 30 - 30'	BA - Black Powder Coat
H-Morgan			BH - White Powder Coat
			BM - Dark Bronze Powder Coat
			BV - Dark Green Powder Coat
			GC - Gray Powder Coat
			.. - Specify Finish

For additional options, download [Decorative Base Catalog here](#)





For additional options, download [Pole Guide here](#)



NEED MORE CHOICES?
For additional Globe options, download [Globe Catalog here](#)

Decorative Bases Ordering Information

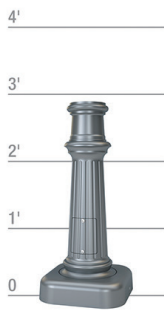
Over 58 Base options available. The most popular listed below. To view all options, download [Base Guide here](#)

 <p>H-Arlen 17 Base Diameter: 17" 4" - 5" - 6" Butt Diameter</p>	 <p>H-York 17 Base Diameter: 17" 4" - 5" - 6" Butt Diameter</p>	 <p>H-Homewood Base Diameter: 11.125" 4" Butt Diameter</p>	 <p>H-Morgan Base Diameter: 13.5" 4" Butt Diameter</p>
---	--	---	---

For detailed design, quote, and specific cut sheet information, contact Lumecon at Sales@Lumecon.com

Accessories Ordering Information

For additional information on Accessories and Options, download [Pole Guide here](#)

Cast Banner Arms

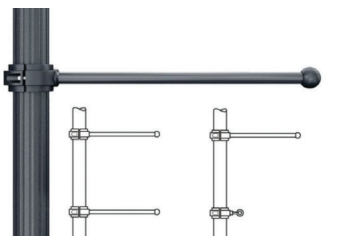

BA27301 - Single
BA27302 - Double
Cast Band Mount
Banner Arms

BA27401 - Single
BA27402 - Double
Cast Band Mount
Banner Arms
Standard Top, Eye
Hook Bottom

Banner Saver Arms

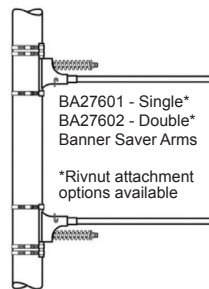

BA27601 - Single*
BA27602 - Double*
Banner Saver Arms

*Rivnut attachment options available

GFI Receptacle Outlet Box

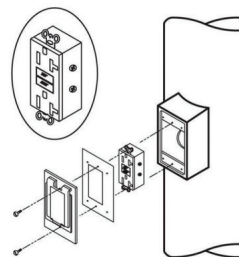

Additional Accessories

- Flower Pot Holders
- FHWA Accepted Break Away Systems
- Additional Hand Holes
- Camera Mounts
- Decorative Arms
- Slip Fitter Tenons
- Vibratoin Dampeners
- Sign Brackets