

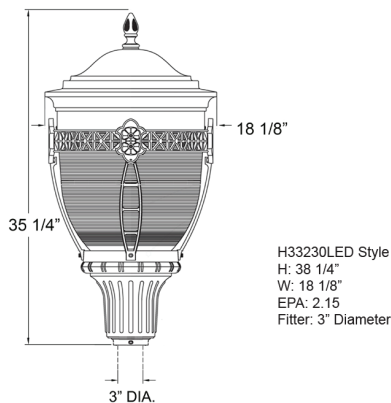

Shown with:  
BH0 Fitter  
H33230LED Style  
Real Spun Copper Top  
Aluminum Available  
Fitter, Arms, and Banding are  
Verde Copper Color  
PI - Prismatic Injection Molded

Requires nominal 3" diameter x 2 7/8" tall tenon



## Technical Specifications

**PRISMATIC INJECTION MOLDED ACRYLIC GLOBE MATERIAL** The North Hills boasts Prismatic Injection Molded Acrylics that are as beautiful as they are functional. During the day, these optical prisms create a mesmerizing "prismatic sparkle" that adds a touch of elegance to any environment. When night falls, they shine as true stars, delivering unparalleled uniformity and light distribution. Efficiency is at the forefront, making the Ambassador an eco-conscious choice for all your lighting needs.

**20-YEAR GLOBE WARRANTY** We believe in the North Hills' enduring quality so strongly that we back it with an exceptional 20-year warranty for the globe. Our commitment to excellence extends to resistance against yellowing, ensuring that the fixture maintains its pristine appearance. With a yellowness index below 7, you can trust your Ambassador will continue to shine brilliantly for years to come.

**FITTER:** Slip fits over 2 7/8" and 3" OD tenons on most decorative poles. Requires nominal 3" diameter x 2 7/8" tall tenon. Uses A356 aluminum comprises 92.05% Aluminum, 7% Silicon, 0.35% Magnesium, 0.20% Iron, 0.20% Copper, 0.10% Manganese, and 0.10% Zinc. It is lightweight and highly corrosion-resistant, like stainless steel. Heat treated to improve strength—low impurities cause high strength and ductility.

**FINISH:** Cast aluminum fitter housing with textured or 60% gloss polyester powder coat finishes for maximum durability. The base aluminum material is prepared using an environmentally friendly non-chrome 2-step surface cleaning and passivation process. The process results in a more durable conversion layer than traditional chromate conversion coatings and allows maximum powder coating adhesion to the aluminum fitter.

**INPUT VOLTAGE:** 120-277V or 347-480V

**EFFECTIVE PROJECTED AREA (EPA):** 0.65 ft<sup>2</sup>

**LIGHT ENGINE:** Each LED light engine consists of a circuit board of 80 Midpower LEDs. The LED board is mounted to a 0.125 aluminum disk and heat sink for maximum heat dissipation from the LEDs.

**LUMECON ETD™ SYSTEM:** The enhanced thermal dissipation system engines are thermally bonded to provide maximum thermal dissipation to the fixture's exterior to ensure long life. To protect the light engine panel from moisture and corrosion, the LED light engine panel is uniformly coated with a UV-stabilized acrylic polymer resin that meets MIL and ASTM dielectric standards, UL, and IPC standards for flammability, moisture resistance, and thermal shock.

**COLOR TEMPERATURE:** 2200K, 2700K, 3000K, 4000K, and 5000K.

**LED LIFETIME:** All LEDs are rated for a minimum of 100,000 hours of continuous operation at ambient temperatures from -40°F/-40°C to 115°F/46°C.

**COLOR RENDERING INDEX (CRI):** Minimum of 80 or higher.

**DIMMING:** 0-10V standard dimming capability.

**SURGE PROTECTION:** Thermally protected 20kA/ 40kV varistor type surge suppressor is included and meets ANSI C136.2- 2015: Extreme Level. It also meets IEC61643-11 Class II / EN61643-11 Type 2 and US Dept of Energy MSSLC Model Spec for surge protection. The device is wired in series with the luminaire input power to interrupt power to the luminaire when consumed, protecting the LED power supply and circuit boards from additional electrical surges.

**BUY AMERICAN ACT:** The product is assembled in the USA and meets the Buy America(n) government procurement requirements under FAR, DFARS, and DOT regulations.

**BABA COMPLIANT:** Meets Build America, Buy America Act Included in the Infrastructure Investment and Jobs Act, Public Law Number 117-58, Title IX, Subtitle A, Part I – Buy America Sourcing Requirements, Sections 70911-70917 stating Manufactured in the U.S. The cost of components mined, produced, or manufactured in the U.S. is greater than 55 percent of the total cost of all manufactured product components.

**CERTIFICATION:** Built with ETL/UL-certified components.

**MANUFACTURING ORIGIN:** US Manufactured and Assembled.

**WARRANTY:** 10 Year L70 performance-based warranty. For full warranty terms, please visit our website: [www.lumecon.com](http://www.lumecon.com).



**PERFORMANCE DATA**

Model	Distribution Type	Watts	2200K		2700K		3000K		4000K		5000K	
			Lumens	Efficacy	Lumens	Efficacy	Lumens	Efficacy	Lumens	Efficacy	Lumens	Efficacy
LM-NH	Type 2	25W	2,500	100	3,100	124	3,125	125	3,500	140	3,500	140
	Type 3	25W	2,575	103	3,175	127	3,225	129	3,600	144	3,600	144
	Type 4	25W	2,450	98	3,050	122	3,075	123	3,425	137	3,450	137
	Type 5	25W	2,475	99	3,050	122	3,075	123	3,450	138	3,450	138
LM-NH	Type 2	40W	4,120	103	5,087	127	5,150	129	5,712	143	5,712	143
	Type 3	40W	4,142	104	5,114	128	5,177	129	5,743	144	5,743	144
	Type 4	40W	4,109	103	5,073	127	5,135	128	5,696	142	5,696	142
	Type 5	40W	4,110	103	5,074	127	5,137	128	5,697	142	5,697	142
LM-NH	Type 2	60W	6,084	101	7,511	125	7,604	127	8,448	141	8,448	141
	Type 3	60W	6,117	102	7,552	126	7,646	127	8,494	142	8,494	142
	Type 4	60W	6,066	101	7,489	125	7,583	126	8,424	140	8,424	140
	Type 5	60W	6,068	101	7,491	125	7,585	126	8,426	140	8,426	140
LM-NH	Type 2	80W	7,982	100	9,854	123	9,979	125	11,104	139	11,104	139
	Type 3	80W	8,026	100	9,909	124	10,035	125	11,166	140	11,166	140
	Type 4	80W	7,958	99	9,825	123	9,950	124	11,072	138	11,072	138
	Type 5	80W	7,961	100	9,828	123	9,953	124	11,075	138	11,075	138

**ORDERING INFORMATION**

Lumecon Midtown Post-Top Series

Example Part Number: LM-NH-H33200LED-40-1-27-T3-BH0-BLK-PC-BL-FAWS

REQUIRED								OPTIONAL		
MODEL	STYLE	WATTAGE	VOLTAGE	CCT	DISTRIBUTION	FITTER	FINISH	PHOTOCELL	HOUSE SIDE SHIELD	DIMMING CONTROLS
LM-NH	H33200LED	20 - 20 Watts	1 - 120v - 277v	22 - 2200K	T2 - Type II	BH0	See Samples on next page	PC - Button Eye	BL - Back Light Louvers	FAWS - Field Adjustable Wattage Selector
	H33230LED	40 - 40 Watts	2 - 347v - 480v	27 - 2700K	T3 - Type III					
		60 - 60 Watts		30 - 3000K	T4 - Type IV					
		80 - 80 Watts		40 - 4000K	T5 - Type V					
				50 - 5000K						

**Product Style Samples**

**H33200LED**  
 H: 35 1/4"  
 W: 18 1/8"  
 EPA: 2.15  
 Fitter: 3" Dia.

**H33230LED**  
 H: 35 1/4"  
 W: 18 1/8"  
 EPA: 2.15  
 Fitter: 3" Dia.

**Available Finishes**

Standard



Premium

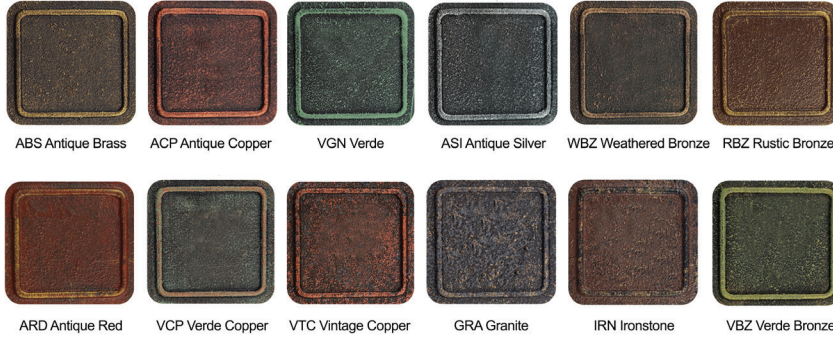

## OPTIONAL BASE AND POLE ORDERING INFORMATION

DECORATIVE BASE OPTIONS	POLE OPTIONS	MOUNTING HEIGHTS			FINISH
H-Arlen-17	Round Straight Aluminum	08 - 8'	14 - 14'	20 - 20'	01 - Satin Aluminum (RTA and RSA)
H-York-17	Round Tapered Aluminum	10 - 10'	16 - 16'	25 - 25'	02 - Satin Aluminum (SSA)
H-Homewood	Round Fluted Aluminum	12 - 12'	18 - 18'	30 - 30'	BA - Black Powder Coat
H-Morgan					BH - White Powder Coat
					BM - Dark Bronze Powder Coat
					BV - Dark Green Powder Coat
					GC - Gray Powder Coat
					.. - Specify Finish

For additional options, download [Decorative Base Catalog here](#)

For additional options, download [Pole Guide here](#)



**NEED MORE CHOICES?**  
For additional Globe options, download [Globe Catalog here](#)

### Decorative Bases Ordering Information

Over 58 Base options available. The most popular listed below. To view all options, download [Base Guide here](#)

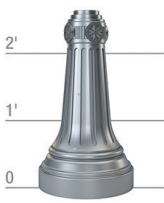
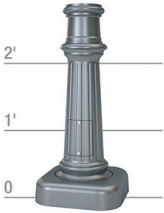
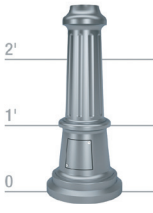
4' 3' 2' 1' 0'	4' 3' 2' 1' 0'	4' 3' 2' 1' 0'	4' 3' 2' 1' 0'
			
<b>H-Arlen 17</b> Base Diameter: 17" 4" - 5" - 6" Butt Diameter	<b>H-York 17</b> Base Diameter: 17" 4" - 5" - 6" Butt Diameter	<b>H-Homewood</b> Base Diameter: 11.125" 4" Butt Diameter	<b>H-Morgan</b> Base Diameter: 13.5" 4" Butt Diameter

**For detailed design, quote, and specific cut sheet information, contact Lumecon at [Sales@Lumecon.com](mailto:Sales@Lumecon.com)**

### Accessories Ordering Information

For additional information on Accessories and Options, download [Pole Guide here](#)

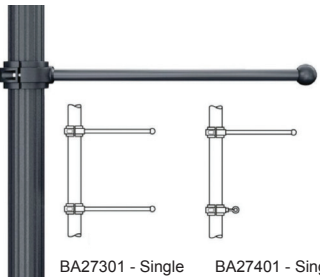
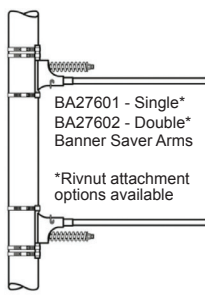
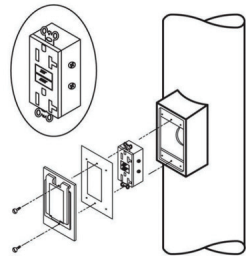
<p><b>Cast Banner Arms</b></p>  <p>BA27301 - Single BA27302 - Double Cast Band Mount Banner Arms</p> <p>BA27401 - Single BA27402 - Double Cast Band Mount Banner Arms Standard Top, Eye Hook Bottom</p>	<p><b>Banner Saver Arms</b></p>  <p>BA27601 - Single* BA27602 - Double* Banner Saver Arms</p> <p>*Rivnut attachment options available</p>	<p><b>GFI Receptacle Outlet Box</b></p> 	<p><b>Additional Accessories</b></p> <ul style="list-style-type: none"> <li>• Flower Pot Holders</li> <li>• FHWA Accepted Break Away Systems</li> <li>• Additional Hand Holes</li> <li>• Camera Mounts</li> <li>• Decorative Arms</li> <li>• Slip Fitter Tenons</li> <li>• Vibratoin Dampeners</li> <li>• Sign Brackets</li> </ul>
--	--	--	--