

PROJECT NAME: _____

CATALOG #: _____

NOTES: _____

DATE: _____

BLS-WSL WALL SCONCE LIGHT

The BLS-WSL wall sconce light is designed to complement the environment without being obtrusive, providing a softer outer appearance. The BLS-WSL has a powerful feature, it supports on-site adjustment of three color temperatures (3000K/4000K/5000K) and four output lumen values, which greatly improves the flexibility of product installation and stocking. Ideal for applications such as lighting walkways and stairways for safety and security and as accent lighting around entrance doors in commercial, multi-family and single family residential settings



SPECIFICATIONS FEATURES

Color Temperature Tuning: Capable of delivering 3000K, 4000K & 5000K color temperatures

Construction: Rugged cast-aluminum housing with bronze powder paint for outdoor applications

CRI: 90

Voltage: 120-277V

Dimming: 0-10V dimming and dimming range from 10%-100%

Lifespan: Estimated 50,000 Hour based on IES LM-80 results and TM-21 calculations.

Operating Temperature: -30°C to 50°C (-22°F - + 122°F).

Power Factor: > 0.90, THD <15%

Listings: cULus wet location listed

Warranty: 5 year warranty

NOTE- Actual performance may differ as a result of end-user environment and application. All values are design or typical values, measured under laboratory conditions at 25°C(±5°C) specifications subject to change without notice.

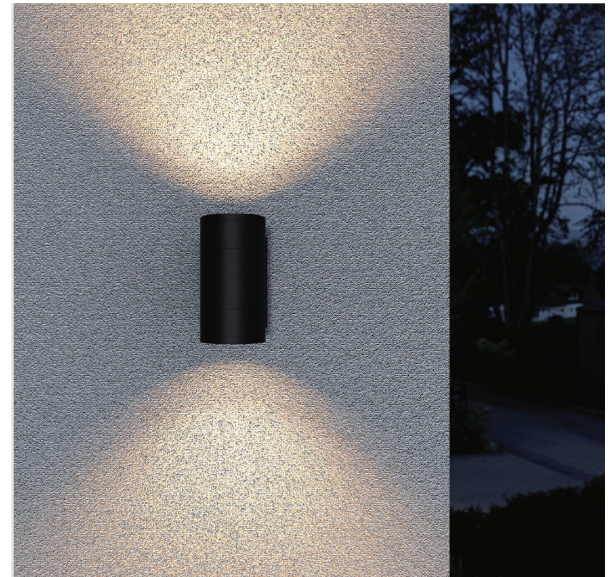

ORDERING GUIDE

SAMPLE: BLS-WSL-36-27V-DDK-D-PC-AD-70



MODEL	WATTAGE	VOLTAGE	CCT	FINISH	PHOTOCELL	CCT & POWER ADJUSTABLE	BEAM ANGLE
BLS-WSL	36 36W	27V 120-277V	DDK CCT Adjustable Color Temperature	D Dark Bronze CC Custom Color	PC With Photocell	AD With Adjustment Dial	70 70 Degree

STRUCTURAL DESIGN



CCT AND WATTAGE SELECTABLE

This fixture has the function of adjusting the lumens output and color temperature on-site.

CCT selectable:
3000K, 4000K, 5000K

Power adjustment range:
Direct & Indirect: 36W-30W-20W-15W

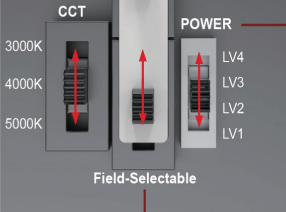

PHOTOCELL CAP

Disable



Enable



FIELD SELECTABLE DISTRIBUTION

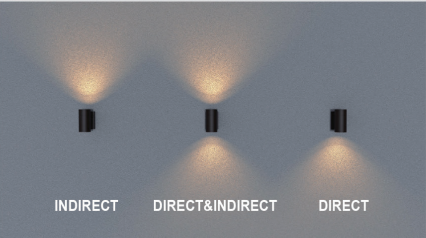

INDIRECT
DIRECT&INDIRECT
DIRECT

PERFORMANCE DATA

BLS-WSL 36W @70 (Full)							
SETTING	SYSTEM WATTS	3000K		4000K		5000K	
		LUMENS (90CRI)	LPW (90CRI)	LUMENS (90CRI)	LPW (90CRI)	LUMENS (90CRI)	LPW (90CRI)
Level 1	36W	3130	87 lm/W	3460	96	3280	91
Level 2	30W	2640	88	2930	98	2750	92
Level 3	22W	1970	90	2200	100	2080	95
Level 4	15W	1440	96	1600	107	1520	101

DIMENSIONS

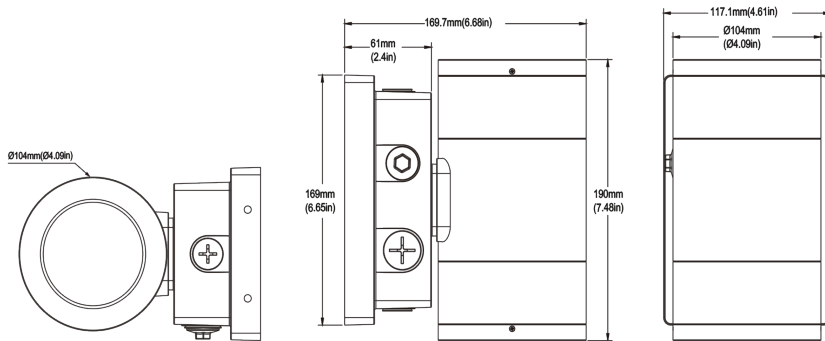

PHOTOMETRICS

