



Catalog Number:	
Project:	
Comments:	
Prepared By:	Date:

Description

The LMB-GB07 walkway bollard is built with an extruded aluminum bollard with a cast aluminum decorative cage and cast aluminum base. The LMB-GB07 is a perfect solution for lighting entrance walkways, retail centers, industrial parks, pathways and for general illumination purposes.

Technical Specifications

Input Voltage: 120-277V

Housing: Bollard - Cast Aluminum (A356) • Anchor Bolts - Hot Dipped Galvanized. Hardware - Stainless Steel.

Lens: Clear acrylic or white acrylic.

Anchorage: 1/2" x 12" Anchor Bolts & Template included

LED Module: 66 High efficacy multi-die array 80CRI—2700K, 3000K, 4000K, 5000K CCT available.

Finish: The fixture will be finished with an electrolytically applied polyester powder coat suitable for exterior use. The bollards are pretreated using industry standard environmentally responsible processes for a long lasting and durable finish.

Color Temperature: 2700K, 3000K, 4000K (standard), 5000K.

LED Lifetime: All LED's are rated for a minimum of 100,000 hours of continuous operation at ambient temperatures from -40°F/-40°C to 95°F/35°C.

Color Rendering Index (CRI): Minimum of 80 or higher.

Dimming: 0-10V standard dimming capability.

Driver: 0-10v Dimming Compatible, 120 to 277 Auto Sensing Class 2, Class P

Minimum Rating: IP66

Buy American Act: The product is assembled in the USA and meets the Buy America(n) government procurement requirements under FAR, DFARS, and DOT regulations.

Warranty: 5 Year performance based warranty. For full warranty terms, please visit our website: www.lumecon.com

LED Light Engine

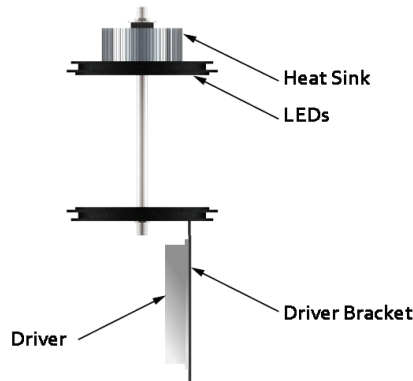

Ordering Information

LMB-GB07 – Round Options / Ordering Example: LMB-GB07-BK-CA-T5-40W-1-40

Model	Color	Lens	Distribution Type	Wattage	Voltage	CCT
LMB-GB07	BK - Black (Gloss)	CA - Clear Acrylic	T5 - Type V	18 - 18W	1 - 120-277v	27 - 2700K
	BT - Black (Textured)	WA - White Acrylic		26 - 26W		30 - 3000K
	SB - Statuary Bronze			40 - 40W		40 - 4000K
	GN - Green					50 - 5000K
	CC - Custom Color					



Dimensions



Anchor Details

- (4) 1/2" Galvanized Steel L-Type Anchor Bolts
- (8) 1/2" Galvanized Steel Hex Nuts
- (8) 1/2" Galvanized Steel Flat Washers
- (8) 3/4" Galvanized Steel Flat Washers

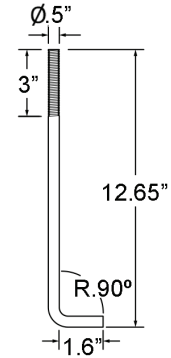

Bolt Circle Details

